

Indonesia: Mangrove-friendly aquaculture

SUKRISTIJONO SUKARDJO

Research and Development Centre for Oceanology
Indonesian Institute of Science
Alamat Jl. Pasir Putih 1, Ancol Timur
PO Box 4801/JKTF, Jakarta 11048, Indonesia
<p3o-lipi@jakarta.wasantara.net.id>

Abstract

The paper describes the mangrove forests in Indonesia, the most extensive in the world. It also describes the causes for their destruction, and the government intervention for aquaculture development ("tambak") and mangrove area conservation ("tambak tumpangsari"). A strategic plan for improving the mangrove areas is presented, including a development program for coastal planning and land zoning process. The paper concludes that "tambak" will continue to be developed to expand fish production. The statement is based on Indonesia's rate of population increase vis-a-vis the certain decrease in natural resources on a per capita basis. Aquaculture would continue to expand while capture fishery declines. Thus, a socio-economic shift to other employment alternatives would be necessary.

Introduction

Indonesia stretches over 5,000 km from Sumatra in the west to Irian Jaya in the east. It is the largest archipelago state in the world with a land and marine territory of about 7.7 million km², consisting of some 17,508 islands with over 81,000 km of coastline. Approximately 75% of Indonesia is marine and coastal waters including 3.1 million km² of territorial seas and 2.7 million km² of Exclusive Economic Zones (EEZs).

Coastal and marine habitats include the most extensive mangrove forests in the world, seagrass beds and spectacular coral reefs which provide breeding and nursery grounds for a large number of commercially valuable fish species, crustaceans (crabs and prawns), bivalves (cockles and mussels), and gastropods (oysters); and a wide variety of endemic animals (e.g. *Nasalis larvatus*). The mangroves are presumably an important carbon dioxide reduction system. Moreover, a rich tradition of artisanal mariculture has evolved along the mangrove waterways, creeks and estuaries. Fish production from these areas constitute an important part of the people's protein supply.

Brief overview of aquaculture

The use of man-made ponds in rearing brackishwater animals has been practiced in Indonesia for hundreds of years. Today, aquaculture is still largely traditional and extensive, and is considered the

most promising short- and long-term means of increasing fish supply and supplementing catch from the natural fishery. It has always been pointed out that the nation's fisheries resources is finite and can not keep up with the inevitable growth in human population.

Fisheries production was reported to have increased from 1.16 million tons in 1968 to 3.5 million tons in 1992, of which 0.34 million tons came from coastal aquaculture. Moreover, some 89,000 tons of shrimps valued at US\$823.4 million were exported in 1992. In 1995, the total value of shrimp and fish export was US\$851 million and US\$1.5 million, respectively. As a result, more mangrove forests are being cleared and converted into "tambak" (brackishwater ponds) in the belief that their operation can be highly profitable or at least can yield a reasonable living.

Significant increases have been made in the volume and value of fish exports, especially shrimp. But over the past six years, the shrimp yield from "tambak" has decreased from a peak of 140,131 tons in 1991 to 79,494 tons in 1995 (Ditjn Perikanan 1996). This decrease is believed to be related to increased levels of pollutants entering the "tambak."

Mangroves

Mangrove areas have long been appreciated in Indonesia as sources of a wide variety of food, construction materials, fuel, dyes and drugs. Inhabitants of coastal zones have traditionally used mangroves for many purposes including wood and energy production.

The use of mangroves vary from site to site on each island, depending on the characteristics of the ethnic population as mangrove dwellers. Majority of indigenous people have access to and use of the mangroves. Such communities have a profound utilitarian knowledge and dependence on the direct and indirect benefits of the mangrove ecosystems.

Along the extensive mangrove fringes of the island coasts, the development of human groups resulted in distinct patterns of cultural adaptation which can still be recognized today. In Sulawesi for example, converting mangroves to "tambak" appears to be part of the locally accepted means to legitimize ownership claims over mangrove areas.

With the advent of industrial and urban requirements for fuelwood among others, mangroves have been an important commodity recognized by both the colonial government and the Government of Indonesia (from 1945 to present). Commercial exploitation is within the purview of the Department of Forestry (DOF) which is responsible for licensing. A Spatial Land-Use Plan (Government Act No. 24/1992) has made the mangrove ecosystem an important element in the conservation and economic development of the coastal region.

Existing mangrove areas

Mangroves are found throughout the archipelago in 22 of the 27 provinces but are concentrated in Irian Jaya, East and South Kalimantan, Riau and South Sumatra (Figure 1). In Maluku, Nusa Tenggara (Lesser Sunda Islands) and other small islands, the ecological conditions are less favorable and the mangroves are small in extent and scattered.

Probably more than half of Indonesia's mangroves are found in Irian Jaya. Mangroves occupy a vast area in the low lying coastal zone, especially in the protected areas with muddy substrates, and in

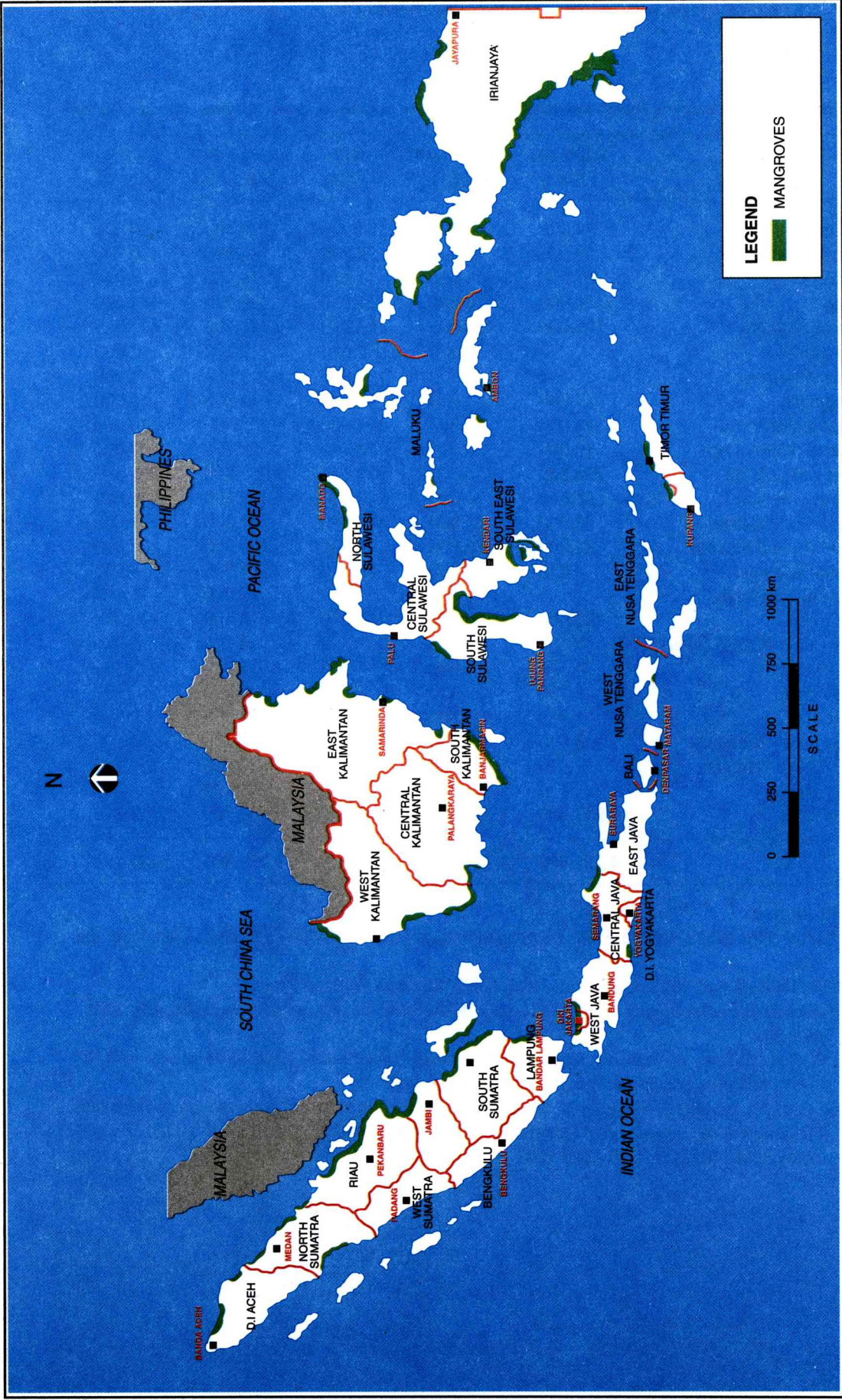

Sumber: Koesoebiono et al., 1982, ODA 1993, ADB 1995

Figure 1. Distribution of mangroves in Indonesia

Table 1. **The mangrove forest areas in Indonesia, by province, from various sources (in ha)**

Province	BIPRAN (1982)	PHPA-AWB (1987)	NFI (1993)	RePPPRoT (1985-1989)	GIESEN (1993)
Aceh	54,335	55,000	102,970	59,400	20,000
North Sumatra	60,000	60,000	98,340	86,800	30,750
Jambi	65,000	50,000	13,450	18,000	4,050
Riau	276,000	470,000	221,050	239,900	184,400
South Sumatra	195,000	110,000	363,430	240,700	231,025
Bengkulu	0	20,000	2,610	2,100	2,000
West Sumatra	0	0	4,850	3,000	1,800
Lampung	17,000	3,000	49,440	31,800	11,000
West Kalimantan	40,000	60,000	194,300	205,400	40,000
Central Kalimantan	10,000	20,000	48,740	28,700	20,000
East Kalimantan	266,800	750,000	775,640	667,800	266,800
South Sulawesi	66,650	90,000	120,780	112,300	66,650
South Kalimantan	66,000	55,000	104,030	67,200	34,000
South East Sulawesi	29,000	25,000	70,840	100,900	29,000
North Sulawesi	4,833	10,000	38,150	27,300	4,833
Central Sulawesi	0	0	37,640	42,000	17,000
Maluku	100,000	46,500	148,710	212,100	100,000
West Java & DKI Jakarta	28,608	5,700	0	8,200	5,000
Central Java	13,576	1,000	0	18,700	13,577
East Java	7,750	500	0	6,900	500
Bali	1,950	500	0	500	500
West Nusa Tenggara	3,678	0	0	6,700	4,500
East Nusa Tenggara	1,830	21,500	10,780	20,700	20,700
East Timor	0	0	4,600	100	100
Irian Jaya	2,943,000	1,382,000	1,326,990	1,583,300	1,382,000
	4,251,010	3,235,700	3,737,340	3,790,500	2,490,185

Data sources

BIPRAN (Dit. Bina Program, Dep. Kehutanan together with FAO/UNDP). 1982. Data from the '70s

PHPA/AWB (Asian Wetland Bureau). 1990-1992. Sumatra Wetland Project

NFI (National Forest Inventory). INTAG, Dep. Kehutanan using Landsat data from early and mid-80s

RePPPRot. Ministry of Transmigration and the British Government. Landsat data from early to late 1980s plus aerial photography and radar imagery

Gieson. 1993. Indonesia Mangroves: an update on remaining area and main management issues. Presented at the international seminar on coastal zone management of small island ecosystems, Ambon; 7-10 April 1993

Table 2. **Mangrove forest category** (Department of Forestry 1995)

Category	Area (ha)	%
Protection forest	424,800	12
Nature reserves	674,600	19
Normal production forest	683,600	19
Limited production forest	372,400	11
Conversion forest	928,900	26
Forest converted	449,300	13
Total mangrove forest	3,533,600	100

There are several provinces with their mangrove areas still in debate, e.g., Bengkulu, West Sumatra, East Timor, Central Sulawesi

large estuaries. They always form an assemblage containing a few species and/or as a luxuriant forest with dense big trees (over 40 m tall and 40 cm diameter breast height) dominating the structure (Sukardjo *et al.* 1980).

The extent and exact limits of mangroves in Indonesia are continually changing. At the seaward side, accretion (deposition of silt and subsequent colonization by pioneer plant species) or erosion (reduction through changes in sea currents) may occur, while at the landward side, a progressive change to "hutan darat" or inland forests may take place.

In view of the constant natural advancement and reduction of mangrove forests, human reclamation of land use, and inadequacy of precise data, recent figures on the extent of mangroves in Indonesia vary (Table 1). Also, the total area of mangrove forest by provinces in Indonesia is uncertain although the general location is known. Various sources have put the total figure between 2.17 and 4.25 million hectares (Table 1) as methods of assessment and interpretation vary widely. The latest (1995) official Ministry of Forestry estimate of 3,533,600 ha is distributed among several categories (Table 2). The figure is still in debate, especially the extent of mangroves in Bengkulu, West Sumatra, Central Sulawesi, West Java and Jakarta, Central Java, East Java, Bali, Nusa Tenggara Barat (West Lesser Sunda Islands), and East Timor.

Value of mangrove resource

Very broadly, mangroves are trees and bushes that grow in tidal zones as littoral plant groups. Its importance is based on the products directly taken from mangrove forests, and on the amenities they provide within and beyond its boundaries. In this context, mangroves are valued more as an ecosystem than simply a group of plants. In modern society therefore, the value of mangrove resources can be classified into:

- direct-use value - products directly derived from mangrove such as firewood, nipa roofing, fishponds, and coastal fisheries
- indirect-use value - protective and support functions such as nutrient recycling, sediment, and erosion control

- option value - this is similar to an insurance payment reflecting the value of future use if options for the potential resource are exercised
- existence value - willingness to pay for conservation of environmental assets even when the resource is not in use

Biodiversity

Indonesia with its wide range of natural habitats, rich plant and animal resources, and high number of endemic species, is recognized as a major world center for biodiversity. Biodiversity is usually considered at three levels: genetic, species, and ecosystem diversity (Bappenas 1993). Many sectors of the nation's economy are dependent directly on the diversity of natural ecosystems.

An estimated 40 million people are directly dependent on natural ecosystems for subsistence. About 12 million people live in and around forests and many more are dependent upon coastal resources. It is the poorest rural people who are most dependent on natural habitats for their livelihood, and it is they who suffer first and most when those habitats are simplified, degraded or otherwise impoverished, but it is the whole nation and the future generations that suffer in the long term.

There are primary, secondary, and marginal mangroves in Indonesia. The primary mangroves constitute the mangrove forests *sensu stricto* as it comprises species in the intertidal zone that are always saline though not salt-demanding, called facultative halophytes. The most important species are *Rhizophora apiculata*, *R. mucronata*, *Avicennia alba*, *A. mama*, *A. officinalis*, *Sonneratia* spp.

The secondary mangroves consist of subsidiary species, such as *Lumnitzera* spp., *Excoecaria agallocha*, *Aegiceras* spp., *Heritiera littoralis*, and also ferns, palms, and herbs.

The marginal mangroves represent species commonly associated with mangroves in landward fringes and occur in seasonal freshwater swamps, beaches, swales, and other marginal mangrove sites. Although they are in mangrove areas, the species are not restricted to the littoral zone. Important species in these sites include *Glochidion littorale*, *Scolopia macrophylla*, *Calamus erinaceus*, *Ficus retusa*, *Melaleuca leucodendron*, and species of sedges and grasses.

Causes of mangrove destruction

The mangrove forests of Indonesia come under increasing threat from a number of developments. In some isolated cases, such as the northern coast of Java, mangrove destruction has been almost total (Sukardjo 1990). The foremost cause of mangrove destruction has been the conversion to other uses such as aquaculture ("tambak"); coastal infrastructure including port, industrial, business and housing development; and agriculture.

Mangroves are also vulnerable to the impact of development activities that occur well beyond it. The most serious threat comes from non-sustainable management of watersheds and the increase in industrial and domestic pollutants that enter the water cycle. Crowded islands like Java have to contend with sediment deposition, alterations in water flow, drainage and pollution. For the islands like Sulawesi, the most serious direct threat is generally believed to be the unofficial clearing of mangroves for fish and prawn culture ("tambak"). Despite the fact that prawn production is beset by problems, small-scale entrepreneurs are still clearing significant areas of mangroves.

The extent of exploitation for wood products varies greatly throughout Indonesia, but overall, they do not appear to be significant when compared with other human activities. What is more alarming

is the perception among the general public and many government officers that mangroves are worthless, that mangrove areas are land suited only as recipient of urban wastes or land that can be converted to other uses. The mangrove's ecological function is not perceived. If this erroneous perception is not corrected, the future of Indonesia's mangroves is bleak.

It can be generally concluded that mangrove destruction occurs through:

- misperception of some people in the country
- overlapping policy of resource use and development
- inefficient coordination among the agencies concerned with mangroves
- conversion of mangrove area to "tambak"
- clearing for new settlement, expansion of old ones, and other infrastructure in the coastal zone development
- forest exploitation by HPH holders
- cutting for fuelwood, others
- siltation from onshore soil erosion from development activities
- land fill, reclamation, use as dumping ground
- pressure from both population and resources extraction

Mangrove utilization

The increase in mangrove forest utilization is a consequence of the national commitment as articulated in GBHN (*Garis Besar Haluan Negara* or Outlines of State Policy) and Repelita (*Rencana Pembangunan Lima tahun* or the National Five-Year Development Plan) (see also later section on policies and legislation). Summaries of the traditional use of mangrove resources are given in Sukardjo & Toro (1989) and Sukardjo & Achmad (1982), and their functions and values are in Sukardjo (1994). Generally, mangroves are used for the following:

- **resettlement areas**

About 60% of the country's population live along the coast. This is about 75% of townships. Mangrove land has been converted to housing development in Kandang Bay, North Sulawesi, and Jakarta, and other places

- **forest resources**

Wood products -- timber, poles, panelling, roof shingles, charcoal, pulpwood -- are some of the commodities derived from mangrove forests. Where these are harvested sustainably, the damage to the ecosystem is negligible.

Indonesia's forestry policy is based on the sustainable management concept. However, there is increasing occurrence of large-scale felling of commercial-quality mangrove forests. By definition, this practice is not sustainable. Although logged-over areas may regenerate, the chances of regeneration usually decrease as the size of contiguous clear-cut area increases (Sukardjo 1987). Aggravating the problem is the conversion of clear-cut areas to other uses (e.g. human settlement, agriculture, "tambak") which effectively destroys the natural resource base. It is only through the acceptance and implementation of proper, non-exploitive silvicultural practices that mangrove resources, goods, and services can be perpetuated for the benefit of the nation and its people.

Timber. Few species of mangroves produce high quality timber (as logs or wood planks) that can be traded on the international market. Although saw mills exist in some localities (e.g. in Muna

Island), the quantity of logs sawn into planks and pots is limited. Generally, however, Indonesia produces more timber from mangroves possibly because of the high stocking density. If the sampled sites represent all mangrove areas in Indonesia, this converts to an estimated volume of 124,745 to 199,646 m³ of wood/ha. It is apparent that medium-sized trees (10-40 cm diameter) are predominant. If growth rate can be pegged at roughly 3% of the standing volume, Indonesia's mangroves might have a mean annual increment of 1.44-5.93 m³/ha/year.

Poles. Mangrove forests in Indonesia were estimated to produce 170,000 poles/year in 1987. Poles are used mainly for foundation piling, scaffolding, and fish traps. The use of *Rhizophora* spp., *Ceriop* spp., *Sonneratia* spp., and *Oncosperma tigillaria* is extensive.

Wood chips. Indonesia today is the main producer of wood chips particularly in Kalimantan, Riau and Irian Jaya. The wood chips factory at Tarakan in East Kalimantan is the only one based solely on mangrove concession. The chips are exported to Japan as raw material in the production of rayon. The mangrove logs used are primarily less than 30 cm in diameter. In 1978, some 382,737 m³ of mangrove logs (mainly *Rhizophora* spp.) worth US\$2.6 million were exported from Indonesia, most of which came from Aceh and Riau provinces in Sumatra (FAO 1985). The wood-chipping operation that was clear-cutting mangrove areas in Bintuni Bay, Irian Jaya, was stopped by the government in 1990.

Pulpwood. The provinces of Riau and Aceh are the major producers of mangrove-derived pulpwood, producing 164,530 m³ worth US\$1,146,018. About 63,000 m³ were exported to Taiwan and Japan in 1997-1998.

In the 1990s, the majority of Indonesian pulpwood was derived from natural mangrove forests which are primarily composed of *Avicennia* sp., *Bruguiera* sp., and *Camostemon* sp. Generally, however, mangroves do not produce high quality pulp. Pulp production has declined significantly in the past decade, and the pressure on mangrove forests for pulpwood was considered negligible by 1996.

Charcoal. Between 1978-1980, charcoal production was estimated to be about 52,000 tons/year. About 42,920 tons were exported in 1980, valued at US\$3.6 million (Biro Statistik 1982). Export rose to 177,833 tons in 1994.

The 1985 Bina Program of the Department of Forestry estimated a potential production of 461,197 tons of mangrove charcoal a year from approximately 1 million ha of forest (excluding Irian Jaya). Charcoal is sourced from *R. apiculata* and *R. mucronata*. Both species have a very high calorific value, producing high quality charcoal for the local and export markets.

Firewood. The mangrove species most commonly used for firewood are *Ceriops*, *Xylocarpus*, *Avicennia*, *Bruguiera*, *Lumnitzera*, *Exoccaria agallocha* and *Heritiera littoralis*. Mangrove wood is still an important source of cooking fuel for coastal villagers in Indonesia and a source of subsistence income. In some localities such as Muna island, firewood collection pose a significant threat to the mangrove forest, but in other areas such as Riau, these products are managed sustainably using the traditional "panglong" system (Danhoff 1946). The wood is usually obtained from small-sized trees (usually less than 7 cm diameter) and is used mainly for daily cooking (called "kayu teki"), while a smaller quantity is burned as insect repellent. Subsistence and

semi-commercial wood cutters use axes and canoes to extract wood, and splitting is sometimes done at home by women. Little is known about the level of firewood production from mangroves in Indonesia though Nurkin (1979) reported production of 26,339 m³/year from South Sulawesi and annual export of 700-1,500 m³ from Riau in 1973-1976.

Tannin. Tannin extraction remains a small-scale operation in Indonesia. Tannin is extracted from the bark (the best one is from *Ceriops*) and is used in the manufacture of ink, plastic and glue, a dye-cum-preservative for fishing nets, batik and in the tanning of leather.

Nipa. The nipa palm *Nypa fruticans* is one of the most versatile and useful trees commonly found in the mangrove ecosystem. Its collection plays an important role in many coastal villages. The Bugis, Bajau, and Javanese use mature nipa leaves for walls, mats, baskets, bags, hats and rain-coats, while the young leaves are used as cigarette and food wrappers. The tough petioles are burned for food or chopped and boiled to obtain salt. The immature, tender kernels are eaten raw, boiled or made into sweet meat. The sweet sap from the beheaded flowering stalk is made into a fermented beverage and vinegar. In South Sumatra, nipa sap is used for making syrup liquor. The yield of pure alcohol from nipa is about 3,000 liters/ha and, with an estimated 1 million ha of nipa palm swampland in Indonesia, mainly in Kalimantan, Sumatra and Irian Jaya, the economic potential of pure alcohol production is considerable.

Others. Another traditional use of mangrove trees is as a source of medicine, and this is still being used in some coastal villages. Various medicinal and cosmetic uses are found for mangrove seeds, roots, bark and latex. Gates, fences, spoons and kitchen items are also fashioned from various mangrove species.

- **Agriculture**

The potential for conversion of mangrove forest *per se* to agricultural land is extremely limited because of the inhospitable physical and chemical environment in which mangroves thrive, namely daily inundation with salt water, very high levels of salinity in the soil and, in some places, the presence of acid sulfate soils. In addition, the soils are considered toxic to most crops because of extreme acidity and high levels of active iron and aluminum that are toxic and that make silicates, molybdenum and trace elements unavailable to crops. There are many examples in Indonesia of successful irrigation schemes in freshwater swamps, but there are probably an equal number of failures. Great care must be taken when attempting to develop swampland be it a marine, freshwater, or peat swamp. One agricultural use for mangrove forests that does not involve planting crops or even disturbing the forest is the collection of mangrove leaves for livestock fodder. Goats are particularly fond of the leaves of *Rhizophora*, and even the older leaves are palatable.

- **Ecotourism**

Tourism should be considered as a potentially non-destructive use of mangroves or, whether directly using mangroves or not, as a potential source of alternative incomes for mangroves residents. To this end, GOI tourism agencies at national, provincial and district levels should be asked to provide input into regional coastal resource management strategies, management plans and the execution of management plans. Because tourism is largely private sector driven, major commercial operators may also have important contributions to make.

Aquaculture development and mangrove area conservation

Aquaculture in the coastal zone offers particular advantages in Indonesia. This, in turn, has led to a classic pattern of dualistic development with modern and traditional systems existing side by side. The Government of Indonesia (thru Presidential Decree No. 39/1980) has adopted policies to promote intensive production and increase the "tambak" area. Thus, coastal aquaculture development during the late 1980s was export-oriented, and "tambak" development was rapid and uncontrolled (Tables 3 and 4). As a result, various social and environmental problems occur with the extension of shrimp ponds into mangrove areas. Moreover, the environmental risks associated with supplying water to the "tambak" are great. Nutrient increases cause major algae blooms in "tambaks" and surrounding waters, which lead to a cascade of numerous problematic events. Thus, any assistance may serve to encourage still more environmentally damaging development of "tambak."

In 1977, "tambaks" covered an estimated 174,605 ha in Indonesia; by 1993, this had risen to 268,743 ha. Although this represents a 54% increase in annual conversion, it is only 5,884 ha/year over a 16-year period. This conversion is the main cause of mangrove destruction, and various estimates show that, at best, approximately 513,670 ha of mangroves have been lost between 1982 and 1993 or 46,497 ha/year. At worst, 17,760,825 ha have been lost or about 160,075 ha/year (Table 1).

At present, there are 109,000 "tambak" households in Indonesia holding about 309,247 ha in 1993 (Biro Pusat Statistik 1994). In the provinces of Riau, South Sumatra and South Sulawesi, large areas of mangroves have been converted to "tambak" shrimp ponds. However, most of these areas are isolated and lack the necessary labor and infrastructure to build an industry. The government's goal of extending "tambak" to these provinces has yet to be met. The mangrove forests in Java, Sumatra and Sulawesi, on the other hand, face a more serious threat from the expansion of aquaculture.

Issues pertaining to "tambak" development are particularly important to sustainability. Therefore, the Government of Indonesia should maintain ownership and control of the mangrove area. This will allow for a more controlled utilization in an integrated and environmentally sensitive manner (e.g., silvofisheries) under an approved ICZM (integrated coastal zone management) land-use plan. At present, the government concentrates on developing a co-existence scheme between mangrove conservation and aquaculture development.

Recognizing the need to conserve its rich biological resources, and following the Earth Summit in Rio de Janeiro in 1992 and Agenda 21 (a comprehensive global work plan for national actions and international cooperation for sustainable development and global environmental protection), the government made a commitment to protect 10% of the land area and eventually 20 million ha of coastal and marine habitats as conservation areas. In addition, it has formulated a *Biodiversity Action Plan for Indonesia* (BAPI) which provides the framework for biodiversity conservation during Replita V and VI and for the 25-Year Development Plan. BAPI covers both terrestrial and aquatic resources and provides the primary reference point for more detailed strategies and action plans that deal with specific biological resources such as mangroves.

Table 3. Estimated areas of mangrove forest in Indonesia and their potential for "tambak" development during Pelita III (1975-1976 to 1980-1981) (DGF 1982)

Province	Mangrove forest (ha)	Potentially converted		"Tambak" (ha)	Potentially converted	
		10%	20%		10%	20%
INDONESIA	4,250,361	421,300	840,300	212,695	367,985	1,053,295
Sumatra	67,335	67,700	133,400	27,125	93,825	160,525
DI Aceh	54,335	6,400	10,800	26,012	31,412	36,812
N. Sumatra	60,000	6,000	12,000	885	6,885	13,000
W. Sumatra	-	-	-	3	3	3
Riau	276,000	27,600	55,200	60	27,660	55,260
Jambi	65,000	6,500	13,000	-	6,500	13,000
S. Sumatra	195,000	19,500	39,000	-	19,500	39,000
Bengkulu	-	-	-	-	-	-
Lampung	17,000	1,700	3,400	165	1,865	3,565
Java	19,935.03	4,900	9,800	114,503	115,403	124,303
DKI Jakarta	95	-	-	1,163	1,163	1,163
W. Java	28,513.16	2,800	5,600	40,257	43,057	45,857
C. Java	13,576.87	1,400	2,800	23,166	24,566	25,966
DI. Yogyakarta	-	-	-	-	-	-
E. Java	7,750	700	1,400	49,917	46,617	51,317
Bali-Nura Tenggara	7,458	700	1,400	3,160	3,860	,560
Bali	1,950	200	400	304	504	704
W. Nusa Tenggara	3,678	350	700	2,558	2,908	3,258
E. Nusa Tenggara	1,830	150	300	298	448	598
E. Timor	-	-	-	-	-	-
Kalimantan	382,800	8,000	76,000	1,589	39,598	77,598
W. Kalimantan	40,000	4,000	8,000	-	4,000	8,000
C. Kalimantan	10,000	1,000	2,000	-	1,000	2,000
S. Kalimantan	66,000	6,500	13,000	414	6,914	13,414
E. Kalimantan	286,000	26,500	53,000	1,184	27,684	54,184
Sulawesi	99,833	10,000	20,000	66,298	76,287	86,298
N. Sulawesi	4,833	500	1,000	193	693	1,193
C. Sulawesi	-	-	-	486	486	486
S. Sulawesi	66,000	6,500	13,000	63,787	70,287	76,787
SE. Sulawesi	29,000	3,000	6,000	1,832	4,832	7,832
Maluku	100,000	10,000	20,000	-	10,000	20,000
Irian Jaya	2,943	290,000	580,000	11	29,011	580,011

Table 4. Extension and development of "tambak" at the end of Pelita IV (1987-1988 to 1992-1993) as consequence of KEPPRES No. 39/1980, by province

Province	Area (ha)	Province	Area (ha)
<i>DI. Aceh</i>	25,000	<i>Bali</i>	1,000
Kabupaten Aceh Besar	4,000	Kaupaten Buleleng	250
Kabupaten Pidi	5,000	Kabupaten Jembrana	500
Kabupaten Aceh Utara	6,000	Kabupaten Badung	250
Kabupaten Aceh Timur	10,000		
<i>Sumatera Utara</i>	5,000	<i>Nusa Tenggara Barat</i>	2,000
Kabupaten Langkat	1,500	Kabupaten Sumbawa	750
Kabupaten Deli Serdang	1,500	Kabupaten Dompu	250
Kabupaten Asahan	2,000	Kabupaten Bima	1,000
<i>Riau</i>	5,000	<i>Nusa Tenggara Timur</i>	1,000
Kabupaten Bengkalis	2,000	Kabupaten Sikka	200
Kabupaten Indra Hilir	2,500	Kabupaten Belu	500
Kabupaten Riau Kep.	500	Kabupaten Sumba Timur	300
<i>Bengkulu</i>	2,000	<i>Timor Timur</i>	1,000
Kabupaten Bengkulu Utara	1,000	Kabupaten Dilly	500
Kabupaten Bengkulu Selatan	1,000	Kaupaten Kovalima	500
<i>Sumatera Barat</i>	1,000	<i>Kalimantan Barat</i>	2,000
Kabupaten Pasaman	500	Kabupaten Pontianak	500
Kabupaten Padang Pari	250	Kabupaten Sambas	500
Kabupaten Pesisir Selatan	250	Kabupaten Ketapang	1,000
<i>Lampung</i>	1,500	<i>Kalimantan Selatan</i>	3,000
Kabupaten Lampung Utara	300	Kabupaten Kota Baru	1,500
Kabupaten Lampung Selatan	500	Kabupaten Tanah Laut	1,500
Kabupaten Lampung Tengah	700		
<i>Sulawesi Ultra</i>	2,000	<i>Kalimantan Timur</i>	7,000
Kabupaten Minahasa	1,000	Kabupaten Bulungan	3,500
Kabupaten Gorontalo	1,000	Kabupaten Pasir	1,500
		Kabupaten Samarinda	1,250
		Kabupaten Balikpapan	750
<i>Sulawesi Tengah</i>	3,000	<i>Sulawesi Tenggara</i>	8,000
Kabupaten Bual Toll	3,000	Kabupaten Kendari	3,000
		Kabupaten Kolaka	4,000
		Kabupaten Buton	1,000
<i>Sulawesi Selatan</i>	30,500	<i>Sulawesi Selatan (con't)</i>	
Kabupaten Maros	1,000	Kabupaten Bone	4,000
Kabupaten Pangkap	1,500	Kabupaten Sinjai	2,000
Kabupaten Barru	1,000	Kabupaten Polmas	1,500
Kabupaten Pinrang	3,500	Kabupaten Luwu	4,000
Kabupaten Takalar	2,500	Kabupaten Kajo	3,000
Kabupaten Bulu-Kumba	2,500	Kabupaten Mamuju	3,000
Kabupaten Jeneponto	1,000		
Total Indonesia			100,000

Organizations and systems related to mangrove preservation

The utilization of mangrove forests involves a multitude of government mainline agencies (at least 18). Considerable confusion has resulted due to overlapping actions by these agencies, and their actual or perceived rights to use the natural resources.

Historically, the planning and management system in Indonesia has been based on sectors or on administrative regions. Sectoral programs include programs for rice, tree crops, livestock and industrial development which are done regardless of socioeconomic, biophysical or topographical conditions. Other programs are designed to cover entire administrative regions, be it districts, provinces or the entire country. This approach does not consider the constraints imposed by local, cultural, economic or ecological factors. Figure 2 illustrates how the agencies and community interact through a mechanism and organization of mangrove management (including mangrove preservation) at the provincial level, while Figure 3 presents the national level diagrammatically.

The conversion of mangroves to other uses falls within the domain of several government agencies. This includes the Department of Agriculture and its Directorate-General of Fisheries, the National Land Board (BPN), the Department of Home Affairs (Dalam Negeri), the Department of Environment (LH), and the Department of Public Works (PU).

At times there has been legislative coordination between the Department of Forestry and other government agencies, such as the 1984 Joint Ministerial Decrees between the Department of Forestry and the Department of Agriculture (*SKB Menteri Pertanian dan Menteri Kehutanan No. KB/550/246/Kpts/1984 and No. 082/Kpts-II/1984 tentang Pengaturan penyediaan lahan kawasan Hutan untuk Pengembangan usaha budidaya Pertanian, and No. 837/Kpts?KB/550/10/1984 tentang Pembentukan panitia Kerja Tetap Penyediaan Lahan Kawasan hutan untuk Pengembangan Usaha Budidaya Pertanian*). This set of legislation discusses conversion of forest land for agricultural and fisheries uses.

Indonesia has basically three options for mangrove management and development:

- preservation of the ecosystem in its natural state
- utilization of the ecosystem to extract various goods and services on a sustainable basis
- conservation (or destruction) of the natural ecosystems, usually for a single replacement use

Policies, legislation and regulations

The legal principles for managing Indonesia's land and natural resources are based on three principles:

- Constitution of 1945
- Basic Agrarian Act No. 5 of 1960 (*Undang-Undang No. 5 Tahun 1960 tentang Peraturan Dasar Pokok-Pokok Agraria*)
- Basic Forestry Act No. 5 of 1967 (*Undang-Undang No. 5 Tahun 1967 tentang Ketentuan-Ketentuan Pokok Kehutanan*)

The elements of official policy and law related to coastal resources management, including mangrove management, arise from the fundamental principles contained in the 1945 Constitution, the State Philosophy (*Pancasila*), official policy guidance adopted as part of the development planning process, legislative enactments, regulatory and administrative actions, and traditional (*adat*)

practices. Much of the detailed policies originate from policy statements adopted at the highest level and expressed through a Presidential Decree or through a coordinated government policy statement. Some of the most important policies may be found in the periodic GBHN (Outlines of State Policy) (Table 5), the Long-Term (25-year) Development Plans (PJPs) and the Five-Year National Development Plans (REPELITA).

At present, the legislative basis for policies related to coastal zone management (CRM), including policies on mangrove management, is somewhat limited. Most current laws establish general policies in three areas: maritime jurisdiction, general environmental protection, and overall management of living natural resources. Since the policies and legislation related to CRM is sectoral in nature, the role and activities of various line agencies are critical. In the case of mangroves, this means some 14 central government line agencies, 3 coordinating ministries and the Dewan Kelautan Nasional.

Legislation pertaining directly or indirectly to mangroves and coastal zones originates from a number of central government ministries and agencies if not directly from the President through Presidential Decrees. In addition to central government agencies, there are 27 provinces in Indonesia each divided into districts. Provincial and district governments are responsible for managing resources and enforcing regulations in their region. Implementation and regulation conform with local priorities via the Spatial Land Use Management Law.

All mangrove forests belong to the government of Indonesia, and mangrove deforestation is prohibited. Laws protecting mangrove forests exist locally via Peraturan Daerah at both provincial and district levels, including moratoria on mangrove conversion to "tambak" and maintenance of the coastal green belt. Government green belt regulations aim to restrict clearance of mangroves for "tambak" close to shorelines, estuaries, and rivers. However, these regulations are ignored (e.g., in Sulawesi), and law enforcement appears to be the main weakness in local mangrove management.

Law enforcement and coordination must be improved, beginning with the integration and coordination of similar but conflicting laws. This must include taking action against those who continue to convert mangroves illegally. Inter-agency coordination is also of paramount importance (Figures 2, 3 and 4).

Existing programs on sound utilization of mangrove areas

(with emphasis on mangrove-friendly aquaculture)

In the current Repelita VI, the government is engaged in a national rehabilitation program for mangroves which involves replanting of 150,000 ha in Java, Bali, Lombok, South Sulawesi, North Sulawesi, Southeast Sulawesi, South Kalimantan, Lampung, South Sumatra, Riau, North Sumatra and D.I. Aceh. Most of the provinces have been seriously affected by "tambak" construction and development (Tables 3 and 4). Reforestation is done in areas where mangroves have been cleared and along shorelines where they have not yet colonized.

Mangroves may be planted for hazard prevention alone or for a form of sustainable economic use. For the latter, there is a basic system dealing with mangrove-friendly aquaculture called "tambak tumpangsari" (sometimes referred as "empang parit") or silvofisheries which combines wood and

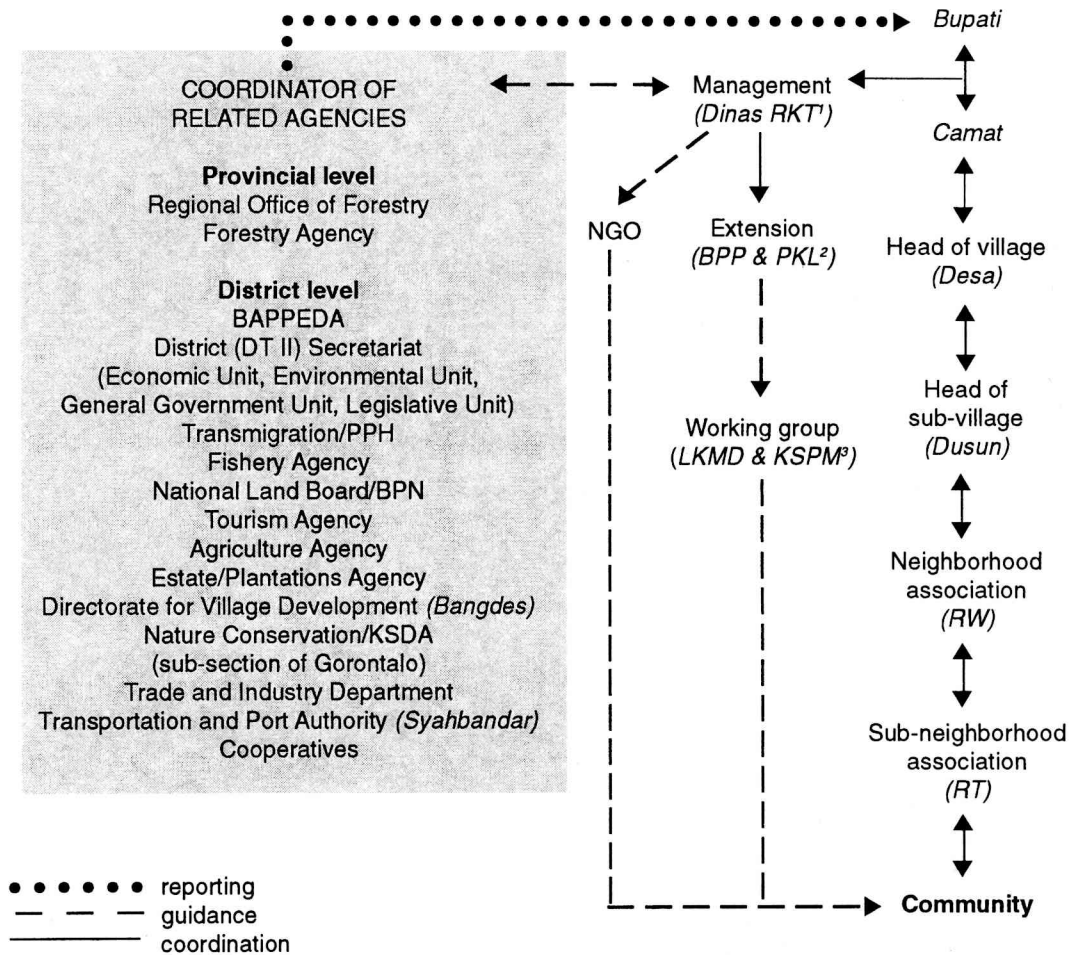

¹PKT - Forest and Soil Conservation Service ([Dinas] Perhutanan & Konservasi Tanah)

²BPP - Agriculture Extension Agency (Balai Penyuluh Pertanian)

PKL - Field Forest Extension (Penyuluh Kehutanan Lapangan)

³KSPM - Mangrove Conservation Self-Support Group (Kelompok Swadaya Pelestari Mangrove)

LKMD - Village Self-Reliance Council (Lembaga Ketahanan Masyarakat Desa)

Figure 2. Mechanism and organization for mangrove management at specific sites

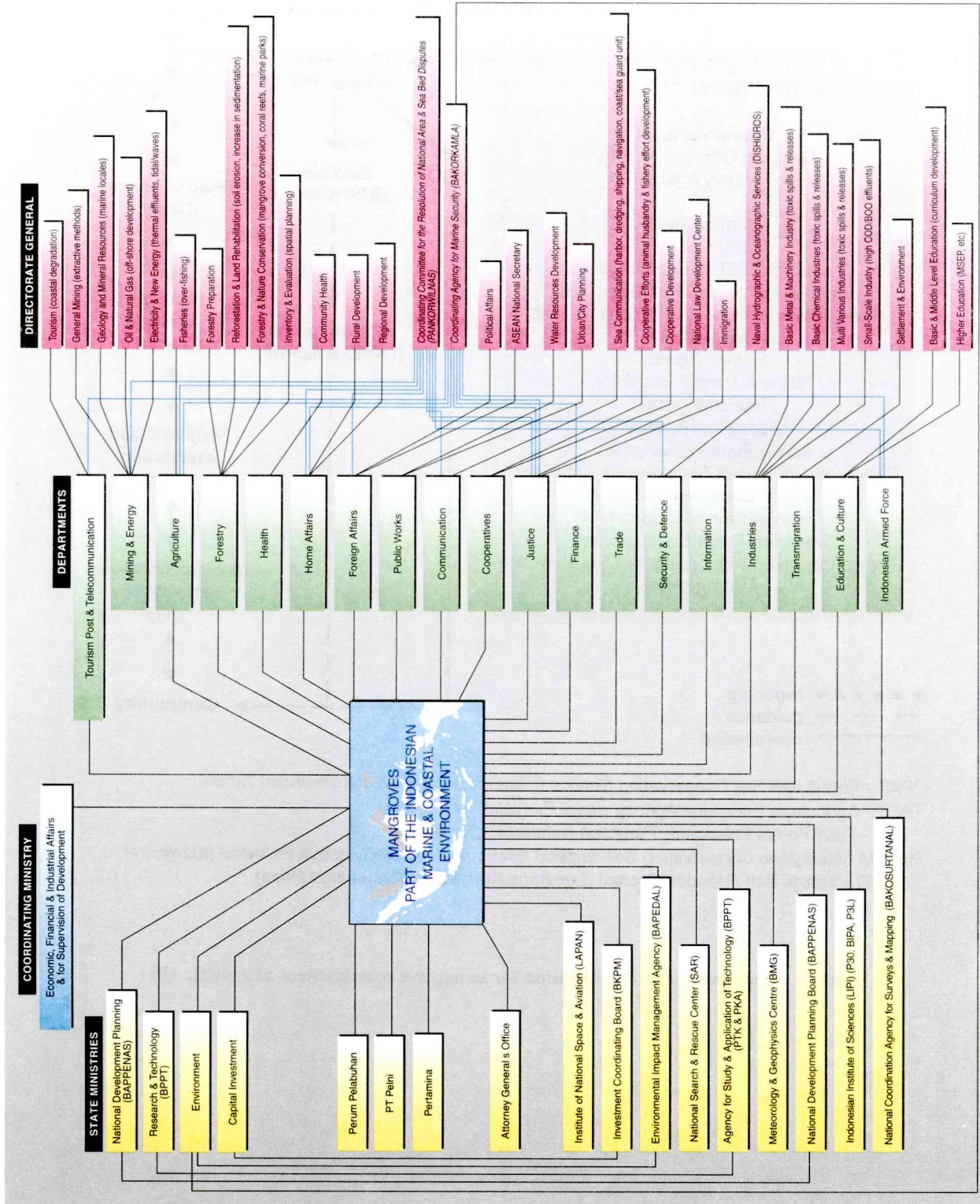

Source: after Dobbin Milus International (1995)

Figure 3. National Agencies relevant to mangrove resource management and pollution control in coastal and marine environments

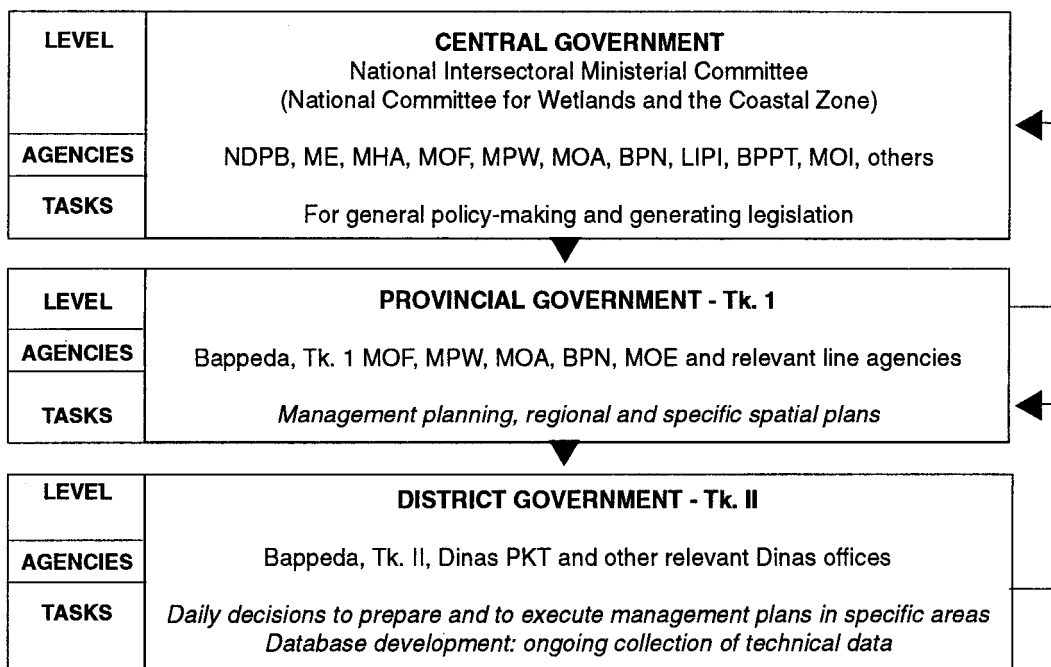

Figure 4. National mangrove strategy: decision-making model

Table 5. The current legal policy guidelines on the environment: summary of the section on economy in the GBHN

- (1) The objectives of environmental development are to increase environmental quality, sustainable use, pollution control and rehabilitation
- (2) Natural resources - land, water and air - must be managed and utilized in accordance with sustainable practices in order to ensure the carrying capacity of the environment to give maximum benefit to present and future generations
- (3) Forests, including their plants and wildlife and their natural beauty, should be protected as well a biodiversity, germplasm, species and ecosystems. Inventories, monitoring and valuation of natural resources and the environment should be developed to ensure the sustainability of these resources
- (4) The degraded environment should be rehabilitated in order to function as life support and to support the well-being of the people. Development of law enforcement should be achieved to decrease environmental pollution. Control should include incentives in combination and in harmony with technology so as to protect the environment and development
- (5) With regard to sustainable development policy, spatial planning will be used to incorporate water and land uses of natural resources within a single framework. Spatial planning will be based upon integrated, regional approaches with emphasis on the characteristics of the natural and social environment. Land-use planning should be used to emphasis the prohibition on converting production agricultural land and disturbing the balance of natural ecosystems
- (6) Regional and international co-operation in environmental protection and enhancement, participation in international environment policies, and dissemination of environmental knowledge and technologies should be increased to ensure sustainable development

fish output. Silvofisheries is a labor intensive technology appropriate for individual or family operation and can be a viable alternative to brackishwater pond culture.

In Indonesia, two project models have been permanently established to benefit the local people and the local government (e.g., Pemerintah Daerah, Perum Perhulani), and to serve as demonstration sites.

Existing programs

"Tambak tumpangsari" is a silvofishery model that is promoted through a national program by the Directorate General of Fisheries. There are large-scale silvofisheries programs in Cikiong (6,600 ha with 1,508 farmers) and Blanakan (5,300 ha with 2,060 farmers) in West Java under the Perum Perhutani (State Forestry Corporation). Unfortunately, controlled production trials with data collection and economic analysis have been very limited (Tables 6 and 7).

The "tambak tumpangsari" model represents the greatest level of reforestation or maintenance of existing forest to "tambak" area (Sukardjo 1989). It also permits a progressive multiplication in the use of mangrove resources from a simple to a more complex stage. The existing project in Sulawesi (MRMPS/Mangrove Rehabilitation and Management) has identified six possible conceptual models, viz:

- (a) replanting for commercial wood harvest
- (b) replanting for household wood harvest
- (c) replanting for "empang parit" system
- (d) replanting with mangrove to give optimum proportion for silvofisheries
- (e) replanting with mangrove for woodlot silvofisheries model
- (f) replanting for integrated mangrove farming

All of these concepts will require the full cooperation of local communities who will need sufficient motivation and incentives to participate. However, silvofisheries alone is not the solution to the problem of coexistence between mangrove and "tambak." Priority should be given to the preservation of critical mangrove areas including coastal and estuarine strips (for shoreline protection), and in sensitive coastal areas where mangrove would be difficult to replant due to existing wave action or thin soils.

Within the Sulawesi mangrove project, fishponds cover 13,048 ha in Luwu (about 40% of original mangrove forests), 332 ha in Lariang (about 6% of original forests), 314 ha in Kwandang (about 10%), and a relatively small area in Muna. It is important to stress that this is no indication of any effective government-mandated moratorium on local conversion of mangroves to "tambak," and there is a distinct lack of coordination among the relevant agencies for coastal management. Thus, the Sulawesi project funded a preliminary study on the constraints and feasibility of aquaculture (including "tambak" and mariculture). The project will continue this study in more detail, fund demonstration models, and provide training on silvofishery and mariculture (e.g., seaweed production) systems that are suitable within the mangrove ecosystem. The successful model will have a significant impact, through demonstration, on villagers willing to participate in silvofisheries development.

The culture system utilized by all farms in all project sites was polyculture while 24-31% of farms practiced monoculture. The species cultured were milkfish, shrimp, seaweed (*Gracilaria* sp.), and

Table 6. Production (kg/ha/year) from "empang parit" in West Java (Anon. 1991)

Location	Total area (ha)	Tilapia	Milkfish	Trash fish	Shrimp	Crab
Bogor-Tangerang	1,113	-	700	200	200	-
Bogor-Ujung Karawang	7,934	-	600	200	200	-
Purwakarta-Cikiong	6,268	-	600	250	250	1
Purwakarta-Pamanukan	4,263	1,500	500	50	300	-
Indramayu-Indramayu	6,421	1,500	500	50	300	-

Table 7. Profits from "empang parit" systems* in Cikiong and Cibuaya (Bagian Kesatuan Pemangkuan Hutan Cikiong and Cibuaya, 1994 and 1995)

	Annual net profit (Rp/ha/year)	Net profit per unit area (Rp/m ² /year)
Mangrove crab*	3,500,000	58,333
Snapper**	3,300,000	330
Tilapia with chicken coop**	6,372,000	637
Milkfish and shrimp**	6,144,000	614
Milkfish monoculture for food and bait**	3,240,000	324

*in 60 m² cage

**"empang parit" with 8:2 forest-to-"tambak" ratio

mud crab (*Scylla serrata*). Average production per unit area and farm income vary significantly among the four project sites (Table 8 a, b and c). There is considerable potential in increasing productivity of shrimp and milkfish. While improving the profitability of "tambak" would provide an incentive to accelerate the rate of mangrove conversion, assistance for aquaculture is justified in areas where the people have agreed to set aside mangrove areas for conservation. Therefore, further "tambak" development should be limited to the upper portion of the intertidal zone while maintaining a buffer zone along the coastline, estuaries and rivers.

Based on the existing program in West Java, it can be concluded that "tambak tumpangsari" has a number of disadvantages compared to "tambak" or open pond. These include:

- management difficulty
- potential toxicity of tannin from mangroves
- greater construction cost per unit of culture area
- lower productivity of phytoplankton and benthic algae due to reduced penetration of sunlight
- limitation on species cultured (e.g., seaweed would be shaded by trees, reducing growth)
- reduced water circulation and greater potential for stagnant waters with low dissolved oxygen

Further research is needed to gather a fuller assessment and an evaluation of the different silvofisheries models shown on Figure 5 a, b, c and d.

Table 8 a. **Production inputs in four "empang parit" project sites**

Project site	Total production	Milkfish seed	Shrimp seed	Labor Use* (person days/ha)	Feed (kg/ha/yr)	Fertilizer (kg/ha/yr)
Luwu	3,539,550	4,494	17,156	135	95	380
Kwandang	8,674,500	5,344	35,550	157	156	1,361
Lariang	2,075,446	3,868	4,836	162	0	66
Mura	179,250	670	1,000	87	13	0

Table 8 b. **Partial productivity by project site**

Project site	Milkfish (Rp/ha/day)	Shrimp (Rp/ha/1,000 fry)	Labor Use (Rp/ha/kg)	Feed (kg/ha/yr)	Fertilizer (kg/ha/yr)
Luwu	788	206	26,219	37,258	9,315
Kwandang	1,623	244	55,252	55,606	6,374
Lariang	537	429	12,811	0	31,446
Muna	268	179	2,060	13,477	0

Table 8 c. **Increase in average production towards a target value of 23,400,00 Rp/ha/yr**

Project site	Current average production (Rp/ha/yr)	Potential average production (Rp/ha/yr)	Percent increase
Luwu	3,539,550	8,504,663	14%
Kwandang	8,674,500	12,335,875	42%
Lariang	2,075,445	7,406,585	257%
Muna	179,250	5,984,438	3,238%

Proposed programs

The current mangrove resources in the Sulawesi project area have been seriously affected by "tambak" construction. Proposed programs on sound utilization aim to address issues related to mangrove rehabilitation. The primary problems, causes and suggested solutions for mangrove degradation at the project sites are summarized in Table 9. The presentation may have oversimplified what is actually a complex set of causes and issues. It must be noted also that as the value of coastal resources rises (e.g., mangrove-friendly aquaculture), pressure on local institutions and its leaders also increases. The whole community must now participate in drawing up land use plans and incen-

Figure 5 a. Woodlot silvofishery design: layout plan for a 25-ha unit (dimensions are to the nearest meter)

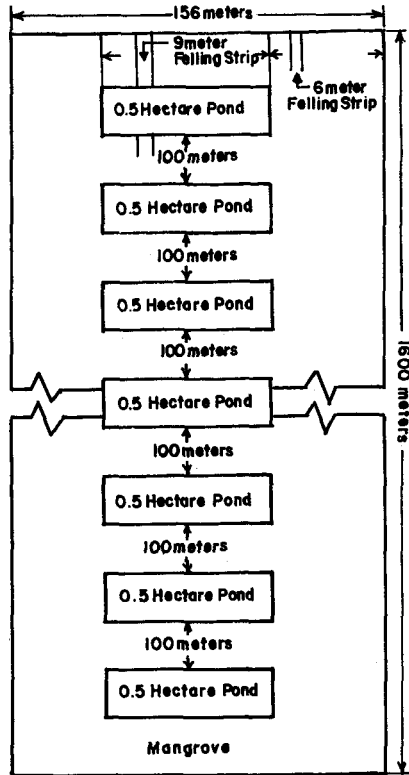

Figure 5 b. Optimum proportion of silvofishery design: 20% pond and 80% mangrove

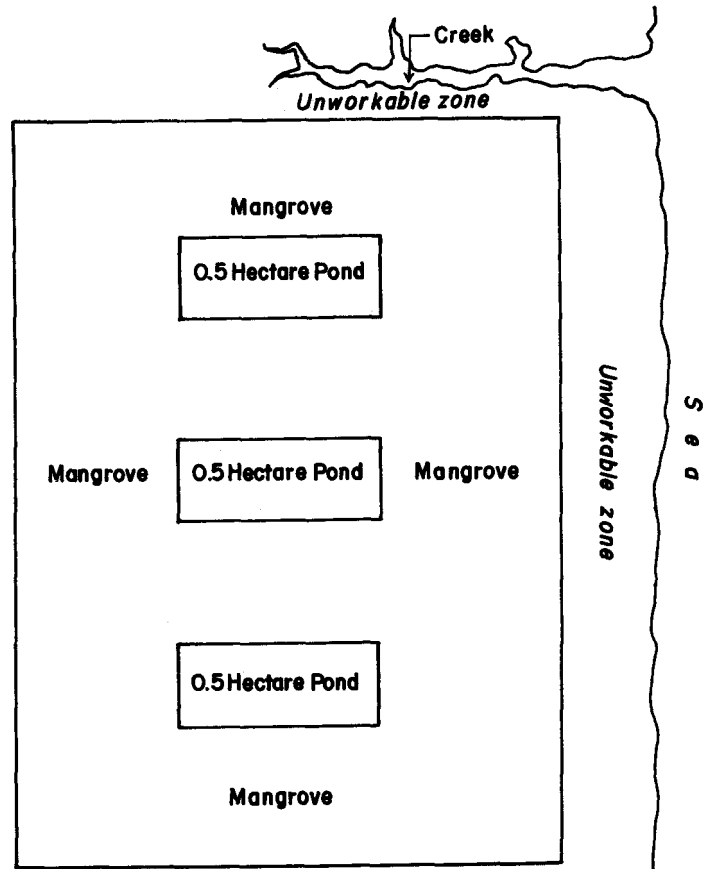

Figure 5 c. Existing empang parit design (e.g., West Java project)

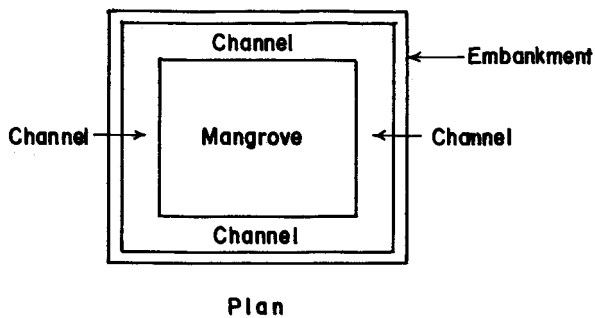
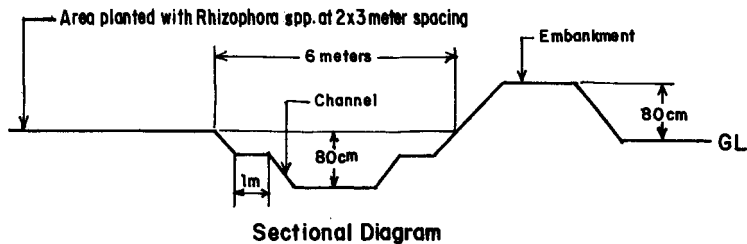
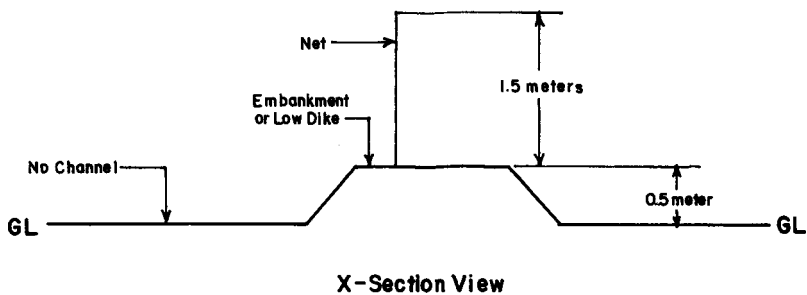
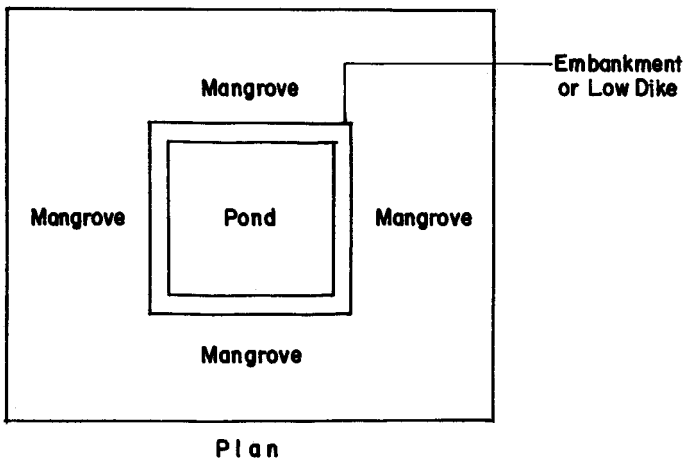

Figure 5 d. Komplangan design



tives in the form of village infrastructure and support for agriculture and "tambak" must be considered. The community will also be made aware of the value of mangroves to offshore fishery through a public awareness or extension program.

Once local communities have agreed to designate certain areas for mangrove conservation and others for "tambak" development, these areas will be mapped and the boundaries physically marked. In Indonesia, legal issues are among the obstacles to the maintenance and development of effective community management institutions. Customary law (Hukum Adat) and community territorial rights (Hak Ulayat) are not mentioned in the Indonesian fisheries statutes dealing with fisheries management, including "tambak tumpangsari." Similarly, the law which authorizes village level governance (Statute No. 5 of 1979) does not recognize community institutions and leadership roles (e.g., the program on mangrove-friendly aquaculture) other than formal government structure.

Given the potential advantages of effectiveness, efficiency and distributive equity offered by local government institutions in the Sulawesi project, the key question becomes whether the government is willing to recognize the rights and the responsibilities of local communities in managing and sustainably developing local mangrove resources. On the other hand, the drive for foreign exchange earnings has blinded Indonesian policymakers and researchers to other coastal aquaculture systems (*viz.* silvofisheries) that provide opportunities for employment and income.

Strategic plan for improving the mangrove areas

Throughout Indonesia, coastal resources have been used by local communities for millennia. Due to their high biological diversity and productivity, these coastal resources are in high demand and pressure to extract resources from them is great. Approximately 65% or more of Indonesia's population, estimated to be at least 215 million by the year 2000, live adjacent or very close to the coastal zone, increasing the complexities of resource management and the likelihood of coastal degradation (Sukardjo 1997). Furthermore, the majority of people within Indonesia's coastal zone live in poverty.

There is a need to develop a strategy that allows "tambak" to exist while the coastal ecosystem maintains its integrity. The preparation of community and government agreements on comprehensive land use including mangrove forest conservation will be prioritized.

Future direction, policies and regulations

With respect to the conservation of biodiversity, Law No. 5 of 1990 (Conservation of Living Natural Resources and Their Ecosystem) adopts the concepts of sustainable use and ecosystem integrity. This law also provides the basis for establishment and operation of protected natural areas, including the coastal zone, e.g., mangrove rehabilitation. One of the chief ways to achieve the purposes of this law is defined in another, Law No. 24 of 1992, which integrates management functions in the context of overall spatial land use management.

Law No. 24 is currently one of the most powerful in that it provides a mechanism for identifying sustainable land use options in the provinces and districts. This all-embracing legislation sees to it that implementation conforms to the spatial plan, especially in connection with efforts to improve mangrove areas in terms of mangrove friendly-aquaculture. It is this law which is likely to provide the foundation for strengthening the legal and institutional framework. However, it must be remembered that even with detailed legislation in place and an improved understanding on the part of

Table 9. Logical framework for proposed investment project activities
(The overall project objective is mangrove conservation)

Problem (location)	Cause	Solution	Project output	Risk to project output
Uncontrolled conversion of mangrove forest (all areas)	Mangrove forest has low value to individuals External value unknown Land use plans do not include mangroves	Incentives for conservation taking into account external value Assess total value of mangroves Comprehensive land use plan	Employment and trade off - (see below) Extension programs Mangrove resource valuation Land use plans agreed with villages Enforcement mechanism	Difficult to deliver incentives In practice, external value is low Insufficient will to enforce land use plans and regulations
Non-sustainable wood cutting (Muna)	Regulations not enforced Lack of employment Good demand for wood	Enforcement of agreed regulations Create other employment Create new uses for mangroves Forest management Reforestation of denuded areas	Micro-enterprises, eco-tourism, handicrafts Forest management plan Replanted areas	Enterprises not profitable or inadequate Incentives, enforcement Poor follow-up care and maintenance
Conversion to "tambaks" (all areas, especially Luwu)	Perceived profitability Source of livelihood Desire to own land	Identify inappropriate areas Trade-off tambak improvement for mangrove conservation Reforest tambak in greenbelt Reforest abandoned tambak	Limit "tambak" development More productive tambak with conservation areas (silvo-fishery) Replanted greenbelt areas Replanted forest areas	Desire to acquire land is over-riding Increased incentive to convert mangroves into tambak Owners require compensation Poor follow-up, care and maintenance
Loss of mangroves on some foreshores (Luwu, Muna, Lariang)	Timber and firewood cutting Foreshore erosion	Reforestation of foreshores Agree on mangrove conservation policy with local people	Replanted foreshore areas	Continuing erosion, site unsuitable Lack of protection from local people

the various agencies of the laws and regulations relating to mangrove use, effective law enforcement can still be undermined by social and economic factors such as low wages for forest guards.

Expanding the resource

The problems and issues pertaining to sustainable management of Indonesia's mangrove resources, including "tambak development," are generally well known and understood. To ensure that potential user conflicts (e.g., among aquaculture, mariculture, fisheries, eco-tourism in the mangrove environment) are kept to a minimum, an integrated coastal zone planning and management scheme (ICZM) needs to be established and implemented.

Strategic plans

The general strategy involves cross-sectoral land use planning that is an integral part of provincial and local spatial planning activities coordinated by local agencies (BAPPED). Some form of ranking or priorities must be given to action plans, and the agency (ies) best qualified to undertake each action must be identified. These action plans, requiring immediate implementation, are referred to as Key Strategic Action and are considered the trigger mechanisms for implementing national and provincial strategies. Strategic plans include key ecological, institutional, socio-economic, and legal aspects (Table 10).

Development programs

Further "tambak" development in the mangroves should be limited to the upper portion of the intertidal zone with maintenance of a site-specific minimum buffer zone along the coastline, estuaries, and rivers (i.e., behind the green belt and preservation areas). Aquaculture zones (i.e., areas for potential development) will be further identified and delineated as part of the second phase of coastal planning and land zoning process. Aquaculture development will be incorporated into an ICZM planning process that identifies the environmental characteristics and carrying capacity of specific areas. Determining the carrying capacity of mangroves, its estuary and coastal areas will be done as part of a baseline data collection.

Existing aquaculture programs

Below are several programs related to aquaculture and concerned with general development of mangrove-friendly aquaculture:

- Identification of suitable areas for aquaculture and the different farming systems
- Development of zoning plans that promote sustainable aquaculture
- Establishment of aquaculture zones (AZs) protected from external environmental pollution (e.g., agriculture chemicals, industrial discharge):
 - Monitoring and protection of water sources for AZs
 - Treatment of farm effluents
 - Provision of long-term leases, infrastructure, training and access to credit
 - Environment impact assessment to be conducted for the AZs as a whole and therefore not required for individual aquaculture activities within the zone provided design and operation comply with established best management practices
- Establishment of an incentive program that promotes sustainable aquaculture development and complies with environmental guidelines:
 - Cheaper and more accessible loans, infrastructure, training and technical assistance for farms that follow set environmental guidelines and best management practices
 - Tax incentives to areas in the industry that need development, for example, hatcheries

Table 10. Key ecological, institutional, socio-economic and legal strategic objectives and action plans

<ul style="list-style-type: none"> • Key Strategic Institutional Actions (KSIA) 	
KSIA-1	<p><i>Objective:</i> To precisely define the location and condition of mangrove resources</p> <p>Action: Implementation of a <i>Nationwide Country Study of Mangrove</i></p>
KSIA-2	<p><i>Objective:</i> To assist the integration of data on mangrove and other coastal resources that are generated by the project under different agencies</p> <p>Action: Prepare <i>Provincial Strategic Action and Mangrove Management Plans</i> for the preservation and sustainable use of mangrove and integrate into a <i>Provincial Coastal and Marine Mangrove Strategy</i></p>
KSIA-3	<p><i>Objective:</i> To protect and conserve a significant proportion of the one million plus hectares of undisturbed mangrove in Irian Jaya</p> <p>Action: Inclusion of mangrove forests in the <i>Lorentz National Park</i> and declaration of this conservation area as a World Heritage Site</p>
KSIA-4	<p><i>Objective:</i> To establish an effective body to coordinate the formulation, implementation and monitoring of a strategy and action plan for the sustainable management of mangroves within the concept of coastal zone resources management</p> <p>Action: The amalgamation of the <i>National Committee on Mangrove Ecosystems and Coastal Zone Management</i> with a recently formed <i>National Wetlands Committee</i> with the prime objective of planning an integrated sustainable resources management in the coastal zone (ICZM). Mangrove and seagrass would be among the resources to be considered by Working Group Subcommittee</p>
<ul style="list-style-type: none"> • Key Strategic Socio-Economic Actions (KSSEA) 	
KSSEA-1	<p><i>Objective:</i> To improve knowledge and awareness of the values of mangrove among all levels of society but particularly among decision-makers and local people who live in and around the mangrove forests</p> <p>Action: Initiation of a <i>National Mangrove Awareness Program</i> in the media and in educational institutions</p>
KSSEA-2	<p><i>Objective:</i> To formulate an appropriate economic evaluation system for mangroves (and other coastal resources) that takes into account the externalities present in any natural system and apply this to the development of sustainable management plans on sustainable development</p> <p>Action: Formulation of a Mangrove Evaluation Sub-Committee or Working Group in the National Committee to address these issues and act as a "clearing house" for proposed methods of measuring "externalities" and as a management plan</p>
<ul style="list-style-type: none"> • Key Strategic Legal Action (KSLA) 	
KSLA-1	<p><i>Objective:</i> To strengthen the understanding, application and enforcement of the Spatial Planning Act in Law No. 24 of 1992 with respect to coastal zone planning</p> <p>Action: Initiate a <i>National Workshop on the Application of the Spatial Planning Act</i> with special reference to its application to the coastal zone in general and mangrove resources in particular</p>
KSLA-2	<p><i>Objective:</i> To achieve legal recognition of the importance of the coastal zone in national development, the interdependence of the natural resource in an integrated manner</p> <p>Action: The coastal environment should receive special legal recognition through the issuance of a <i>Presidential Decree</i> that shows an integrated approach to coastal issues including the management of mangrove</p>

which can reduce dependency on wild seed and related pressure on fishery resources (e.g. loss of target and non-target species through collection for aquaculture)

Proposed improvements

The proposed program to improve mangrove areas will need provisions for monitoring and impact evaluation (e.g., changes in land use and vegetation cover, socio-economics). Also, the activities will involve GIS/mapping, field survey and proposals for potential sites for mangrove rehabilitation and management. Soil investigations will be limited to reconnaissance level surveys with measurements for pH and salinity made in the field.

Recommended approaches (national and regional levels)

The recommended approach will be ICZM which can maximize coastal zone benefits and minimize conflicts and constraints that work against these benefits.

Creating awareness

National plans will need to include educational and training programs and publicity at the community level on how mangroves contribute directly and indirectly to people's livelihood through mechanisms such as support to offshore fisheries and land protection from wave erosion.

Indonesia has very diverse human culture and ethnic groups. There are also very diverse perceptions on mangroves and "tambak." Clearly linking income generating activities and mangrove conservation will be essential in creating awareness.

National plans must promote community organization and participation. Village organizations will also be involved in joint forest management and in identifying income-generating activities. There are SPAP (Social Preparation and Awareness Program) undertaken by NGOs, among others, including reorienting community members to community-based management. To provide villages with further incentives and immediate benefits from project participation, small but significant infrastructure (e.g., small bridges, walkways, landing stages or piers, improving water supply) may be funded.

Licensing

As part of the regulatory control process, a licensing program of all commercial activities based within mangrove areas should be established. This is to serve as a basis of development control that balances all needs (environmental, development, and social). The licensing program, along with regulations, requires diligent and equitable enforcement. Without enforcement, uncontrolled development and law/regulatory abuse will be detrimental to conservation programs.

Sustainable and responsible management plans

In Indonesia, there is still a lack of understanding of mangrove ecosystems and many decisions on the future use of mangrove land are based on inadequate knowledge. Sometimes, this has resulted in sometimes irrevocable loss of valuable mangroves. It is particularly important that local community aspirations are assessed through direct personal contact and considered in sustainable management plans or district spatial plans (Figure 2). For planning purposes, Resource Management Areas (RMAs) have been identified to manage coastal resources. The RMAs contain different combinations of resource-use options and/or activities. RMAs in the intertidal zone focus on options for

managing mangroves and "tambak" (Mangrove Management Zones). Before any management plan can be made effective it is essential that the district authorities clarify ownership status in mangrove zones and in the whole coastal zone. With its broad jurisdiction over all coastal forests, including mangrove forests, the Ministry of Forestry should be considered the most influential agency with respect to the direct management of mangroves and other living coastal resources.

Education and training

The current mangrove resources have been seriously impacted by "tambak" development. Therefore, assistance programs to "tambak" farmer communities should be part of an overall management strategy for the mangrove habitat. For any conservation program to succeed, the full participation of the "tambak" community is essential due to their intimate physical and economic connection with mangroves. Being a full participant strengthens the final development, conservation and zoning regulations and raises the likelihood of compliance with regulations concerning preservation of the mangroves. Education and training should include:

- Training of fisheries extension officers -- technical skills in aquaculture need to be improved to effectively implement an extension and training program directed at "tambak" farmers
- Skill enhancement of "tambak" farmers -- improvement of skill and entrepreneurship is essential for the sustainable development of mangrove-friendly aquaculture
- Community-based training in environment awareness -- there is very low awareness of environmental and ecological issues concerning the mangroves or the marine environment in the general community
- Mariculture training -- marine fish, sea cucumbers, shellfish, seaweed, and other marine crops cultured in the "tambak" should be targeted for special training modules
- Backyard hatcheries for milk fish (BHM's) specialized training -- for Fisheries Extension Officers and prospective entrepreneurs
- Comprehensive Project-Related Training Framework Plan -- academic training for M.Sc. and Ph.D. degrees within the country or overseas in the field of brackishwater aquaculture, mangrove, spatial planning, remote sensing, others
- Project Participant training -- the courses are for village leaders (formal and informal), farmers, fishers, women, and the youth
- On the job training (OJT) -- a summary of OJT courses includes GIS, spatial planning, mangrove rehabilitation and management planning, and communication (SPAP component)
- In-Service Technical Training -- this is training for trainers (TOT) covering mangrove extension for forestry, fisheries, food crops, estate crops PPL's, mangrove rehabilitation and management for local NGOs; laws and regulations for *camats* and *kades*; spatial planning for mangroves and coastal areas for Bappeda TK. II and SBRLKT; and GIS orientation for managers and technicians

Applied research

Ecosystem research tends to focus on natural and pristine systems where the influence of human activities need not be considered. But for mangroves, there is growing awareness that the social and economic sciences and management aspects must be included in ecosystem research. Table 11 lists research modules that need to be studied in detail.

Table 11. Mangrove research modules in line with an ICZM land-use plan

Module 1 --

- Record of the space-and time-related variables of abiotic parameters: geographic description of the hydrographic system and abiotic parameters in the study area and its seasonality; the regional climate
- Concomitant investigations of the environment

Module 2 Mechanisms for the maintenance of biodiversity in mangroves --

- Inventory of the fauna: investigation of the distribution, abundance and dominance of relevant species
- Ecological niches; competition and displacement phenomena; critical minimum size of populations and areas
- Importance of a decrease in biodiversity for function and structure of the mangrove ecosystems; consequences of a sustainable utilization of mangrove resource on biodiversity

Module 3 Description of the socio-economic environment --

- Assessment of structure and functionality of the economic, socio-cultural section of the system in this region
- Interactions between the sections; role of external socio-economic enforcement
- Change through time, and their present development trends; assessment of resource extraction and its sustainability

Module 4 Availability, biomass, productivity and utilization of animal and plants --

- Assessment of the primary production of mangrove trees and their epiphytes as well as of phytoplankton
- Primary productivity of microbial organisms
- Assessment of the spatial and time variability of individual primary producers with regard to the total production

Module 5 Identification of the major energy-and material-transport paths --

- Assessment of energy sources and carriers
- Chemical cycles (carbon and nitrogen)
- Definition of trophic levels; detritus food chain and microbial loops

Module 6 Modelling of the mangrove system and recommendations for a sustainable development --

- Establishment of a data bank (Mangrove Information System, MAIS); evaluation of existing ecosystem models for mangrove
- Quantitative assessment of energy and material within the various compartments of the ecosystem as well as of the socio-economic general conditions, formulation of their mathematical relationship with the objective to describe and predict the behavior of the mangrove ecosystem
- Derivation of management recommendations under consideration of political, social and legal circumstances following the ICZM concept

Assessment studies

- Environmental Impact Assessments (EIA) in planning for large projects and conduct area-wide EIA's for areas zoned for aquaculture development (AZs). Rehabilitation bonds or guarantees may be required for large aquaculture developments to protect the environment from potential unsustainable or mismanaged aquaculture investments
- Environmentally sound guidelines on site selection, water quality, and effluent discharge; or best management practices for aquaculture farms in general

Impact research

- Conduct applied research relevant to on-farm production needs
- Develop commercial hatchery production procedures for key species and promote establishment of private sector hatcheries
- Establish a priority listing of species for a focused research program oriented towards commercialization within a reasonable time frame (e.g., 5 years)
- Research the optimization of inputs (e.g., water, seedstock, fertilizer, chemicals) for sustainable aquaculture/mariculture activity at different production intensities
- Research and develop silvofishery design and operational procedures to maximize production within an integrated mangrove and aquaculture system

Socio-economic goals

- Develop clear, reasonable and implementable national and local policies for aquaculture that are consistent with national goals of economic growth and environment protection
- Develop a coherent comprehensive national aquaculture plan that promotes sustainable use of resources
- Establish a coherent legal framework for the aquaculture industry at all levels. A recommended procedure is as follows:
 - Review existing legislation affecting aquaculture to determine relevance and compatibility with national objectives
 - Establish a Code of Practice which outlines general practices and guidelines for environmentally sound design and operation. This Code is an interim step prior to legislation and formulation of a national aquaculture plan. All stakeholders in the industry, including small-scale operators, should be involved
 - Develop specific legislation that clearly promotes the national policy regarding aquaculture development
 - Establish a review committee of relevant agencies with private sector representation that periodically reviews legislation
- Establish an industry monitoring system that involves farmers and commercial investors to assure that policies would accurately reflect the status and composition of the industry
- Establish an aquaculture licensing system for balancing conflicting interest in the coastal zone. The licensing system limits the number and size of established farms and allows the control needed to harmonize the needs of aquaculture with those of the local community, health standards and environmental quality
- Establish policies linking conservation with economic incentives and incorporate them into national development plans (e.g., incentives for silvofisheries)
- Integrate aquaculture into national development policies
- Provide adequate funding to carry out national goals and objectives regarding aquaculture development and monitoring

- Provide adequate resources to the Fisheries Service (Department of Agriculture) to carry out development, management, and monitoring programs (e.g., research, extension demonstration, infrastructure)

Mangrove-related fisheries

Indonesia is an archipelagic state where the physical characteristics of the islands are reflected in the extent of mangrove forests. These physical dynamics influence mangrove productivity, and healthy mangrove ecosystems can benefit offshore fisheries. Greater densities or wide greenbelts would reduce coastal erosion, and make sure that mangrove habitats serve as fish nurseries (e.g., milkfish and other seafood species). This would positively affect demersal fisheries. Therefore, the continued destruction of mangroves could cause a rapid collapse of what is still a highly productive fishery.

In Bone Gulf, it has been reported that commercial capture fisheries is quite lucrative because the mangrove ecosystem and associated seagrass and coral communities still retain their functional integrity. The ecosystems also support coastal fishery, seaweed mariculture, and aquaculture. In Kwandang, North Sulawesi the mangrove supports a productive crustacean fishery with an estimated yearly harvest of 5.5 tons of shrimp (=2 kg/ha/year) and 15 tons of crab (6 kg/ha/year).

Resource evaluation

Ecological and economic considerations can not be separated in evaluating management alternatives for mangroves. This statement reflects the growing appreciation of the social and economic importance of mangrove ecosystems. To measure the value of mangroves accurately, the value of the goods and services produced by the ecosystem needs to be considered and incorporated into the assessment of the relative merits of development alternatives. This requires the application of innovative economic evaluation techniques that take into account such externalities.

Minimum areas of mangrove to be conserved/preserved

The following management interventions are recommended, viz:

- Protection areas -- all mangroves along the coastline should be reasserted as Protection Forest, with DG-RRL Department of Forestry as responsible for its management. This area is primarily for protection and maintenance of a 200 m greenbelt
- Rehabilitation areas -- mangrove areas that are degraded or damaged need enrichment planting and reforestation
- Community forestry area -- healthy mangroves areas wider than 200 m greenbelt, especially along the populated coasts, could be managed by communities using low impact and other sustainable forestry practices

The above designation is used to describe and define areas recommended for Protection Forest status under the Ministry of Forestry classification system. In areas showing extraordinary biodiversity or that remain relatively intact as wide expanses of mangrove habitats, the most logical land use is a very restricted one. Protection should be formalized by declaring that all mangrove areas of 200 m or less width are afforded Protection Forest status.

Regarding "tambak" development, there is still debate on the criteria for the minimum area of mangroves to be conserved/preserved. Generally, about 10% of total mangrove forests should be conserved and/or preserved as nature reserve, marine national park, sanctuary, greenbelt, and protected forest.

Aquaculture/mariculture models

The recommended aquaculture/mariculture model in Indonesia consists of four zones across the mangrove area (seaward to landward) as the ecological basis for further development (Figure 6). The width of the zones will vary according to the site or total width of mangroves. A narrow band will result in the constriction or elimination of landward zones.

This model calls for a shift of new "tambak" pond (non-silvofishery) development to the area behind the mangroves. A description of the zones is as follows:

- Zone I - Mariculture. The area seaward of the mangroves and the adjacent estuaries has potential for mariculture, including raft, cage, pen and stick-line culture of seaweeds, coral reef fish, lobsters (mainly holding), sea cucumbers, shellfish, and other species
- Zone II - Greenbelt or preservation area. No aquaculture activity should take place here
- Zone III - Conservation or silvofishery. The area is a transition zone that would allow limited economic utilization of the mangrove area, but in an integrated sustainable manner that preserves the overall integrity of the mangroves. Silvofisheries would be an appropriate activity at the ratio of 8:2 (mangrove area to water canal). Silvofisheries should be restricted to designated aquaculture zones (AZs) within this zone
- Zone IV - Utilization or silvofishery. The proposed utilization zone still maintains a level of integrity in the mangroves with the use of silvofisheries. The proposed ratio is 1:1 (mangrove area to water canal) in silvofishery ponds. Silvofisheries should be restricted to designated AZs within this zone

The model is mainly targeted at areas with currently limited aquaculture activities but are under pressure for development (e.g., in Sulawesi-Lariang, Muna and Kwandang). An important point in implementing this model is the enforcement and maintenance of controlled development within an overall land-use program. In locations where the mangrove area is under government ownership, it is recommended that this remain unchanged or used only for long-term conditional leases. Certificates of ownership will not be issued.

In privately owned areas, land-use regulatory measures can be implemented, however, this has proven to be difficult to enforce. Private land ownership will require greater economic usage of the land compared to government ownership. Therefore, "tambak" development would have to be considered as land-use option; however, this should be controlled and limited to specific areas (AZs).

Practical technologies on mangrove-friendly aquaculture

The alternation of mangrove and pond (Figure 7) is the recommended silvofisheries model. It has the maximum ratio of mangrove to pond culture area and still be able to provide superior management and production. Variations in the ratios can be made based on environmental conservation, development and policy considerations. It is recommended that units of 2 and 4 ha pond areas be standardized as the model units with individual pond size of 1 ha.

Some key considerations in design include the following:

- ratio of water area to pond dike length -- reflects proportion of production area to capital investment)
- gate width -- important in allowing wild seedstock to enter pond and in flushing out decayed excess mangrove debris). It should be more than 50 cm/ha

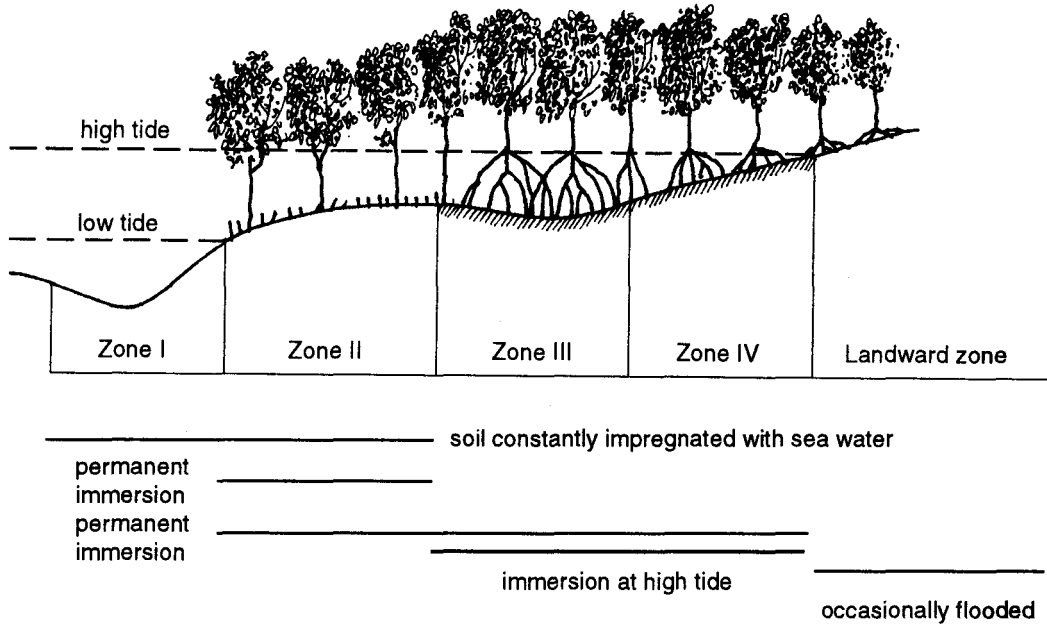

Figure 6. Aquaculture/mariculture zones across the mangrove area

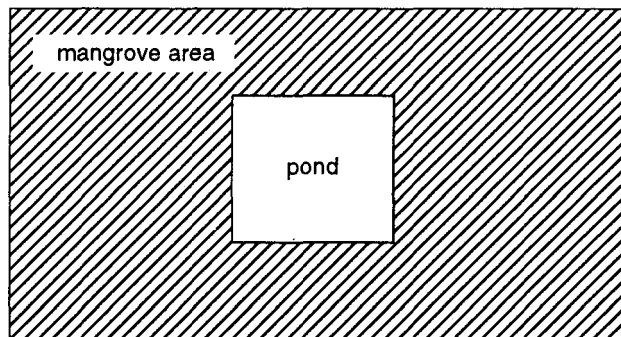

Figure 7. A 10 ha silvofisheries site with 8:2 mangrove to "tambak" area (not to scale)

- tidal flushing rate and tidal range
- flow of water within a pond to prevent stagnation and low oxygen level
- depth of water, depth and width of perimeter channel
- site location -- soil sustainability and abundance of natural stocking material

For fish culture, the traditional system is used. For crustacean culture, there is mud crab culture in pens and traditional shrimp culture method. Mollusc culture uses rafts, seaweed culture uses stick-and-line and anchored floating rope systems. All these farming systems are constrained by the level of inputs, skills and capital. It is advisable, however, that aquaculture is limited to semi-intensive culture practices (moderate stocking density, supplemental feeding, increased water exchange, no mechanical aeration) on the current cleared land holding.

"Tambak" farmers also need to be trained. It is evident from surveys and interviews that technical training has been minimal or nonexistent. Experiences have been gained through trial and error, often without full understanding of why changes in production occur. Without this understanding, sustained improvement of the aquaculture industry will be constrained. Training programs must be a vital and fundamental component of any effort to improve production of "tambak" operations in the country, particularly in silvofisheries.

Problems related to mangrove-friendly aquaculture

The government policy with regards to extensification and intensification of "tambaks" is not appropriate to the sustainability of "tambak" operations. Extensification has had a negative impact on mangrove forests, with the greatest expansion of "tambak" occurring in the 1980s (Tables 5 and 6). Intensification, on the other hand, creates a substantial increase in nutrient loads in pond effluents, and with the high level of "tambak" development in the project areas, this would likely place an excessive burden on the environment with resulting eutrophication problems. Also, high acidity and acute toxicity of heavy metals cause problems in aquaculture in general.

With regards to "empang parit" system, the problems as observed in the farms at Sinjai, S. Sulawesi are:

- The two gates are located on the same side of the pond. This results in canal water having a reduced water flushing, resulting to a greater build-up in organic matter on the bottom and greater chances of water stagnation
- The mangrove trees are extremely dense in the central platform. The trees contribute a large amount of organic matter to the pond. With the reduced water flushing, this has the potential of increasing BOD and reducing oxygen levels
- The construction of pens for mangrove crab culture in the central platform will further add to the organic matter and associated decomposition of by-products. The additional input of 5% of mangrove crab biomass may increase the BOD to a detrimental point and the build up of hydrogen sulfide in the pond bottom
- With the tidal height of only 50 cm in the pond, this reduces water exchange
- The pond canals cannot be completely drained, since the bottom is below the lowest tide. This results in greater stagnation potential and eliminates the periodic drying and oxidizing of built up organics in the pond bottom
- Large amount of organic debris in pond dikes make the dike susceptible to shrinkage, leakage and erosion (some already occurring on the inner slope)

Concluding remarks

"Tambak" will become the single important means of expanding fish production in Indonesia during the coming decade. This is a potentially controversial statement considering the vast breadth and diversity of the country's fishery and aquaculture sectors. However, the statement is based on: (a) indisputable trends that Indonesia's population will continue to increase while its natural resources will certainly decrease on a per capita basis; and (b) strong hypotheses that aquaculture will continue to expand, while capture fishery production will soon stabilize and eventually decline.

Indonesia's population of 182 million in 1990 is increasing at an annual rate of about 2.1% (2.15% from 1980-1985, BPS 1987). New government population data released after December 1990 indicate that Indonesia's population is actually about 178 million. Although efforts to curb population growth have produced measured success (Indonesia and President Suharto have received international acclaim for this), population growth is likely to continue at about 2% because the Indonesian population is exceptionally young with 36% below 14 years of age and 80% (146 million) under age 40. Based on age distribution of the 1990 population, the number of potential parents will increase at a rate of more than 1 million per year through at least year 2010. At 2% growth rate, the population will double to 365 million persons within 35 years (by 2025), during the life-time of at least two-thirds of the present population. This means 5 million new persons per year. The government is concerned about how to feed, employ and otherwise provide services to so many persons.

Indonesia is a nation of fish eaters, and in the next 35 years -- or even in the next 5 years -- the scenario would be as follows:

- Demand for fish to fulfill domestic and export markets will grow at an even greater rate
- Arable land area will decrease as competition for land resources increases (arable land will be required for increased housing, roads, industry and other non-agricultural purposes even with efforts to protect those lands)
- Capture fishery yields will stabilize and likely decrease because of overfishing (as well as pollution and other causes) as a direct result of increased competition for all fisheries resources. In order of probable decline will be the (1) traditional high-value food species, (2) the low-value food and (3) eventually the industrial or fish meal/trash species
- Some freshwater and marine fish stocks will disappear from the fishery (this has already happened in some areas)
- Capture in some freshwater and shallow sea fisheries will decline to a principally subsistence level (this has also become a reality in some locations)
- Employment throughout all fishery sub-sectors will decline primarily because of a stabilizing and declining fishery and modernization of fishing technology

Consequently, a socio-economic shift to other resources for employment alternatives will likely be necessary for a very large segment of the population.

References

- Bappenas. 1993. Biodiversity action plan for Indonesia. Ministry of National Development Planning/National Development Planning Agency, Jakarta 1993. 126 p
- Biro Pusat Statistik. 1994. Statistik perikanan di Indonesia
- Danhof GN. 1946. Over omloon en bedrijf van bakau-bakau in den Riau-Lingga archipel. *Tectona* 36:59-72
- Ditjen Perikanan. 1996. Eksport import basil perikanan Indonesia antara. Januari-Oktober 1993. *Gapindo*, Edisi X: September 1996
- FAO. 1985. Mangrove management in Thailand, Malaysia and Indonesia. *FAO Environment Paper* 4. 60 p

- Nurkin B. 1979. Aspek-aspek pengusahaan hutan mangrove di Sulawesi Selatan. In: Soemodihardjo S *et al.* (eds). Pros. Seminar Ek. Hutan Mangrove, 158-160. LHL 26, Jakarta 1979
- Sukardjo S. 1987. Natural regeneration status of commercial mangrove species (*Rhizophora apiculata* Bi. And *Bruguiera gymnorhiza* (L) Lmk) in the mangrove forest of Tanjung Bungin Banyuasin district South Sumatra. For. Ecol. Manage. 20: 233-252
- Sukardjo S. 1989. Tumpangsari pond as multiple use concept to save the mangrove forest in Java. Diotrop Spec. Publ. No. 37: 115-123
- Sukardjo S. 1990. Conservation of mangrove formations in Java. In: Bass K *et al.* (eds). The plant diversity of Malesia, p 329-341
- Sukardjo S. 1994. Conservation strategy of the mangrove forest in Indonesia: A functional consideration. In: Wells PG and Ricketts RJ (eds). Coastal Zone Canada '94. Cooperation in the Coastal Zone, Conference Proceeding Vol. 3, 1062-1095. CZC Asso, 1994
- Sukardjo S. 1997. ICZM in Indonesia. In: Solomon W (ed). ICZM: Principles and Practices. Springer, Bremen, Germany
- Sukardjo S, Kartawinata K and Yamada I. 1984. The mangrove forests in Bungin river Banyuasin South Sumatra. In: Socpadmo E *et al.* (eds). Proc. of the Asian Symp. on Mangroves: Research and Management, 121-141. Unesco and Univ. of Malaya, Kuala Lumpur, 1984
- Sukardjo S and Akhmad S. 1982. Mangrove forests of Java and Bali (Indonesia). Biotrop Spec. Publ. No. 17: 191-201
- Sukardjo S and Toro AV. 1987. Pendaya-gunaan hutan mangrove dalam perkembangan budidaya tambak di Indonesia. Jurnal Litbang Pertanian VI (4): 95-104
- Sukardjo S and Toro AV. 1988. Guidelines for the protection and management of mangrove and estuarine wetlands in Indonesia. In: Field CD and Vanucci M (eds). Proc. Symp. on New Perspective in Research and Management on Mangrove Ecosystem, 203-225. Unesco, New Delhi, 1988