

Technical Report No. 5

August 1980

Fishing gear for prawn and shrimp used in the Philippines today

Hiroshi Motoh



**AQUACULTURE DEPARTMENT
SOUTHEAST ASIAN FISHERIES DEVELOPMENT CENTER**

Tigbauan, Iloilo, Philippines

**Fishing gear for prawn
and shrimp used in
the Philippines today**

Hiroshi Motoh

TABLE OF CONTENTS

	Page
Introduction	1
Materials and Methods	2
Descriptions	3
I. Gear for penaeid fry	5
Stationary gear	6
Mobile gear	16
II. Gear for adult prawn and shrimp	22
Set impounding nets	22
Mobile impounding nets	33
Entangling net	40
Discussion	41
References	42

FISHING GEAR FOR PRAWN AND SHRIMP USED IN THE PHILIPPINES TODAY

Hiroshi Motoh

INTRODUCTION

Statistics show the annual production of prawns and shrimps to be 33,664 metric tons with a selling value of some P173 million (US \$23 million) in the Philippines (Anonymous, 1978).

As far as the present author is aware, six reports on fishing gear are available in the Philippines. Talavera and Montalban (1932) enumerated and described 27 kinds of gear (including variations) not only for shrimp and prawn, but also for crabs and finfishes from Panay, Negros and Cebu. Umali (1950) in his "Guide to the classification of fishing gear in the Philippines" described more than 50 types of gear consisting of hand instruments, barriers and traps, lines, and nets. Domantay (1973) described 19 types of shrimping and prawning gear which were classified into five categories: set impounding nets, mobile impounding nets, entangling nets, guiding barriers, and miscellaneous gear. Delmendo and Rabanal (1973) described and illustrated four types of cropping gear used in sugpo (*Penaeus monodon*) culture ponds. Primavera and Apud (1977) reported five types of gear for transferring juvenile *P. monodon* and/or for harvesting the adults in brackishwater fishponds. Motoh (1980) illustrated eight typical devices and gear for catching the wild sugpo fry (postlarval *Penaeus monodon*).

The present paper describes various types of shrimping and prawning gear and devices, most of which have been traditionally used in the Philippines with some ecological notes. This study provides basic information on prawn culture and fry collection, which will be useful for private fishpond operators and workers.

MATERIALS AND METHODS

The shrimping and prawning gear described were observed during the field surveys on prawn ecology which was conducted almost throughout the Philippines, northward to Aparri (Luzon) and southward to Zamboanga (Mindanao), from 1976 to 1980 (Fig. 1) by the present author.

Illustrations made by the scientific illustrator, Mr. Panfilo Legaspi, Jr., were based mainly on actual observations by him and partly on colour photographs taken by the author. The gear are classified into two groups: gear for fry and adults which can be further categorized into three groups: set impounding nets, mobile impounding nets, and entangling nets. This grouping has been slightly modified from the description of Domantay (1973).



Fig. 1. Map showing places visited during the field survey.

DESCRIPTIONS

There are presently 22 kinds of gears in use: nine for collecting sugpo fry (postlarval *P. monodon*) and 13 for capturing adult prawns as categorized and shown in Table 1.

Table 1. Prawning and shrimping gear used in the Philippines today (local names are enclosed in parentheses).

I. For prawn fry, mostly <i>Penaeus monodon</i> (sugpo or lukon)	Area operated
A. Stationary gear	
1. Fry lure (bonbon, bungot-bungot, habong, pagumpong, palipi)	Mangrove area, brackishwater river
2. Fry filter net (tangab)	Shore waters
3. Capiz patterned filter net	Mouth of brackishwater river
4. Fry raft (saplad)	do
B. Mobile gear	
5. Fry seine (sabay, sagap, sayod, sibut-sibot, suyod)	Shore waters
6. Triangular net or scissors net (hudhud, sakag)	do
7. Fry bulldozer or fry dozer (baka-baka, traveller)	do
8. Fry scare line (surambaw)	do
9. Scoop net (sibut-sibot, dusdus, salap)	Mangrove area, brackishwater river

II. For adult prawn and shrimp (Penaeids)	Area operated
A. Set impounding net	
1. Fish corral (baklad, bungsod, taba, tower)	Mouth of brackishwater river, bay
2. Prawn trap (aguila, bukatot, paabang)	Inside and outside of prawn pond
3. Filter net (saluran, sangab, taan)	Mangrove canal, fishpond
4. Lift net (bintahan, sumbadahan)	Brackishwater river, bay
5. Lever net (salambaw)	Mouth of brackishwater river, interior portion of bay
6. Cover net (pingpong)	Mangrove area, brackishwater river
B. Mobile impounding net	
7. Cash net (laya)	Mangrove area, brackishwater river
8. Triangular net (hudhud, sagap, sayud, sudsud)	Mangrove canal, brackishwater river, shore waters
9. Beach seine	Shore waters
10. Baby trawler	Bay, mangrove area
11. Skimming net	do
12. Otter trawler	Open sea
C. Entangling net	
13. Gill net (pante, panti)	Bay, mangrove area, open sea

I. Gear for penaeid fry, mostly *P. monodon* locally called "sugpo" or "lukon"

In rural areas, fry concessionaires use widemouthed earthen jars, locally called "kulon" or "palayok", 36 cm in outer diameter (Fig. 2) for holding sugpo fry. Some 2,000 sugpo fry can be stored in the jar when half-filled with approximately 20 liters of seawater for 2 to 4 days without aeration. The advantage of this kind of native container is that it provides relatively lower water temperature (by about 1.5°C) due to the porosity of the jar, resulting in evaporation of water from its outer surface. In addition, it is cheap and locally available. Recently, some fry concessionaires as well as collectors use white plastic basins, 86 cm in diameter and 15 cm in depth, instead of "kulon" as the basin is more durable and makes counting of the blackish brown fry easier against the white background. It is for the same reason that a white plastic cup is used for removing fry from the container instead of the half coconut shell (dark-brown in color)

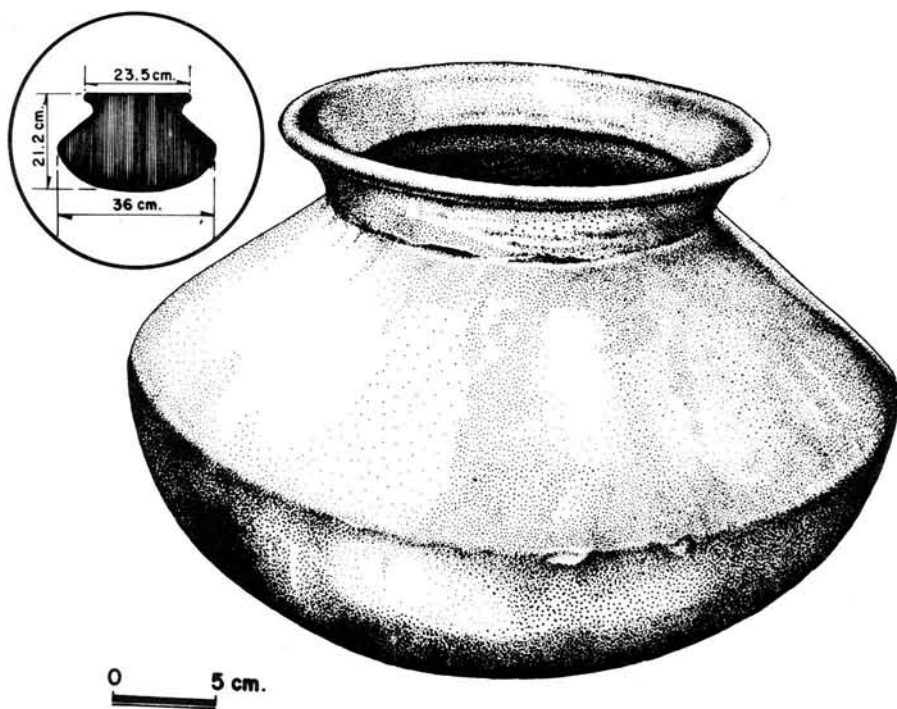

Fig. 2. Earthen jar "kulon" or "palayok" for holding sugpo fry.

A. Stationary gear

1. Fry lure (Fig. 3)

Fry lures locally called “bonbon”, “bungot-bungot”, “habong”, or “pagung-pong”, are simple devices made of bundles of twigs, brackishwater grass (*Paspalum vaginatum*), or coconut peduncles. The fry lures are usually set in mangrove creeks or brackishwater rivers where they are protected from strong currents or waves. Each lure is tied to a long line of rattan string or hung on wooden poles at intervals of 1.5 to 2 m and placed near the banks of brackishwater rivers. Sometimes they are directly set in shallow brackishwater areas. Fry collectors visit the lures during low tide, mostly in the early morning, and place a dipping scoop net, locally called “salap” or “dusdus” beneath each bundle of the lure. The collector then shakes the lure vigorously to remove the clinging sugpo fry into the dip net.

This lure is effective for collecting the sugpo fry due to the clinging habit of the fry in brackishwater nursery grounds.

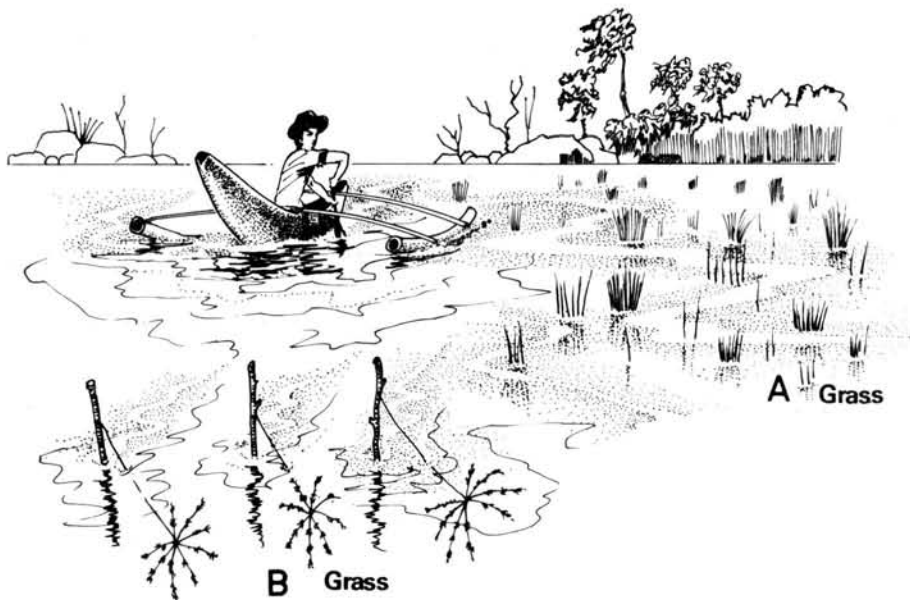

Fig. 3a. Types of fry lures: A, grass lure embedded in mangrove soil; B, grass lure hung on wooden poles.

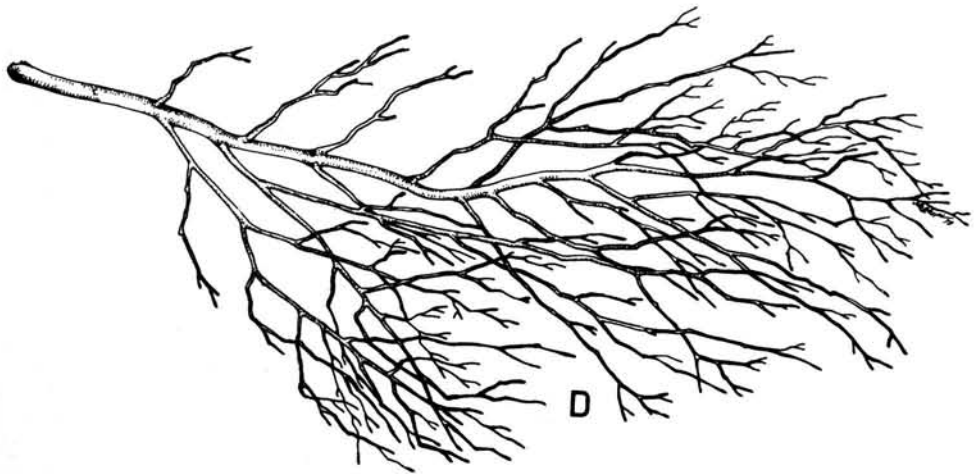
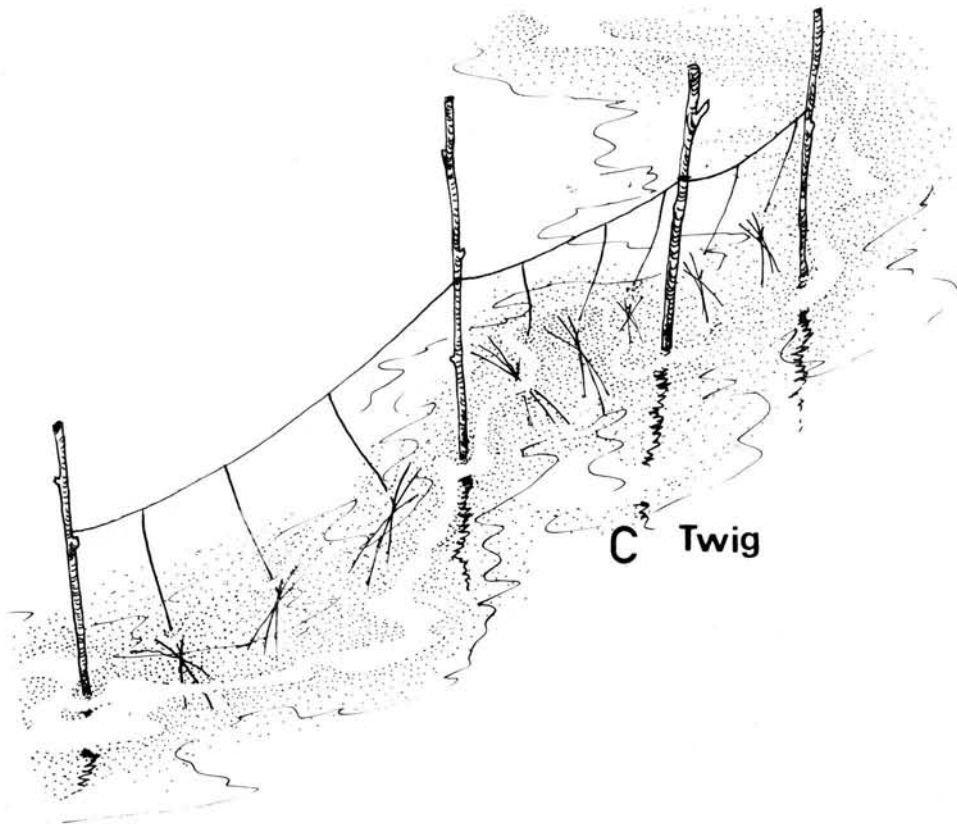

Fig. 3b. C, twig lure tied to a rattan string; D, large twig used for attracting fry.

2. Fry filter net (Fig. 4)

The fry filter net, locally known as "tangab", is made of main and guide nets and two pieces of bamboo, wooden or iron sticks. Unlike the mobile gear, this net requires water current accompanied by moderately strong waves.

The gear is usually located near the shore in water up to 2 m deep. Two poles are positioned obliquely to the shoreline against the current. Instead of moving the gear, the fry are carried with the current into the net. From time to time, the fisherman removes the contents of the codend (terminal portion of the net) which contains not only the penaeid fry but also many other organisms, and brings them to the shore for sorting.

The operator can sometimes collect more than 200 sugpo fry within an hour, particularly during the monsoon season. This gear is adapted to the behavior of the sugpo fry when migrating and/or being transported with wind-blown and tidal currents approaching the shore water, particularly when the water is turbid during flood tide.

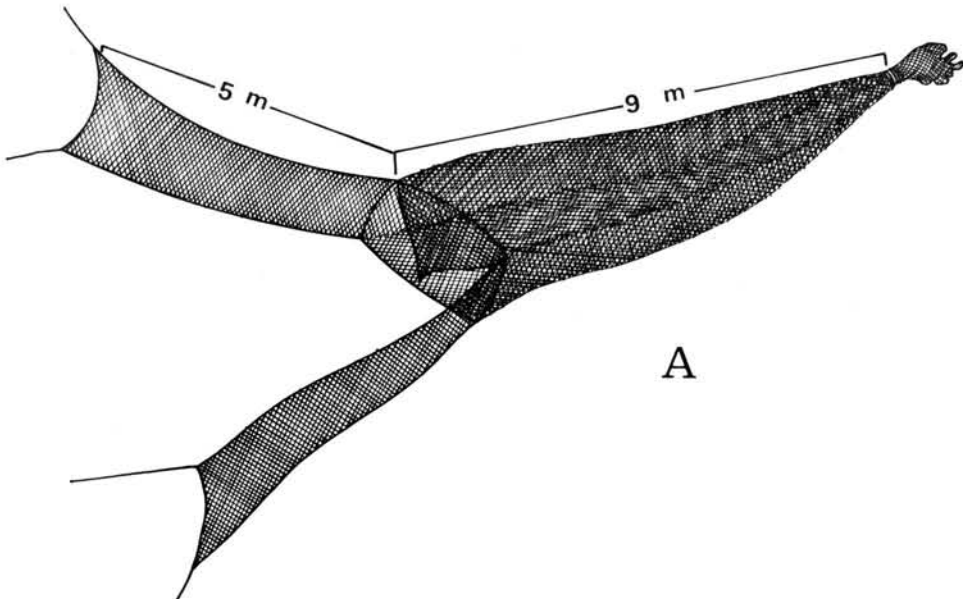

Fig. 4a. Fry filter net.

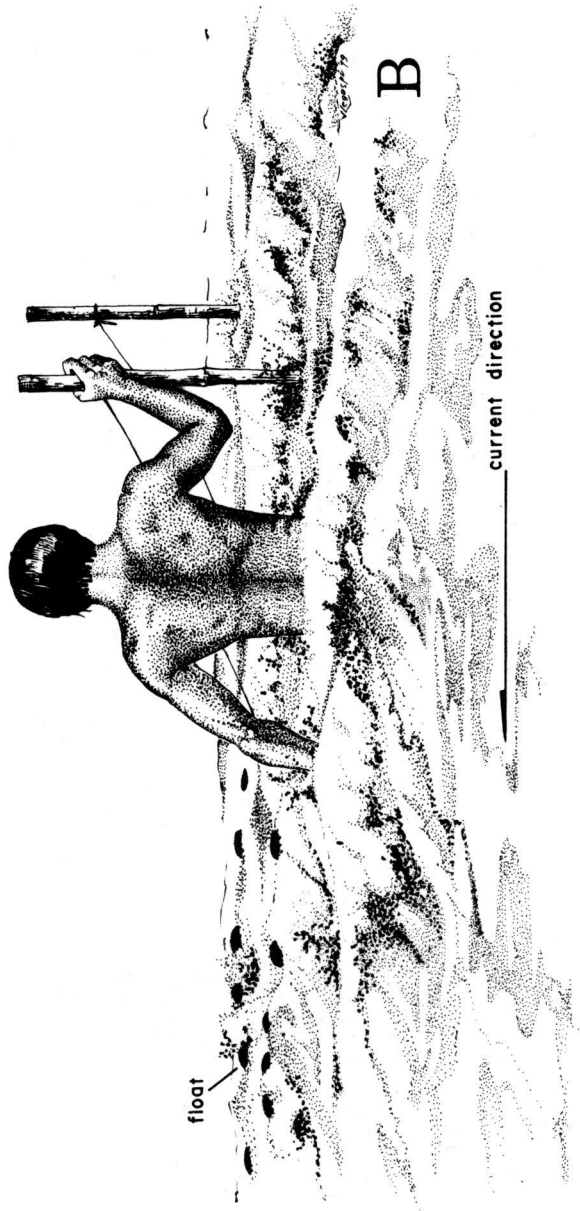

Fig. 4b. Operational view of fry filter net.

3. Capiz patterned fry filter net (Figs. 5, 6)

This stationary gear consists not only of netting parts but also of a bamboo raft and one small nipa hut. There are some twenty bamboos which serve as a raft and platform for operation. The nipa hut on the raft serves as a resting place for the operator. In the front, bamboo poles holding the guide nets are held far apart.

This fry raft facing downstream in a brackishwater river is usually operated during flood tide for the purpose of collecting the fry migrating from offshore spawning grounds to brackishwater nursery grounds with the incoming tide. The name "capiz" was derived from Capiz Province, northern Panay Island, Philippines, where the traditional fry raft was modified.

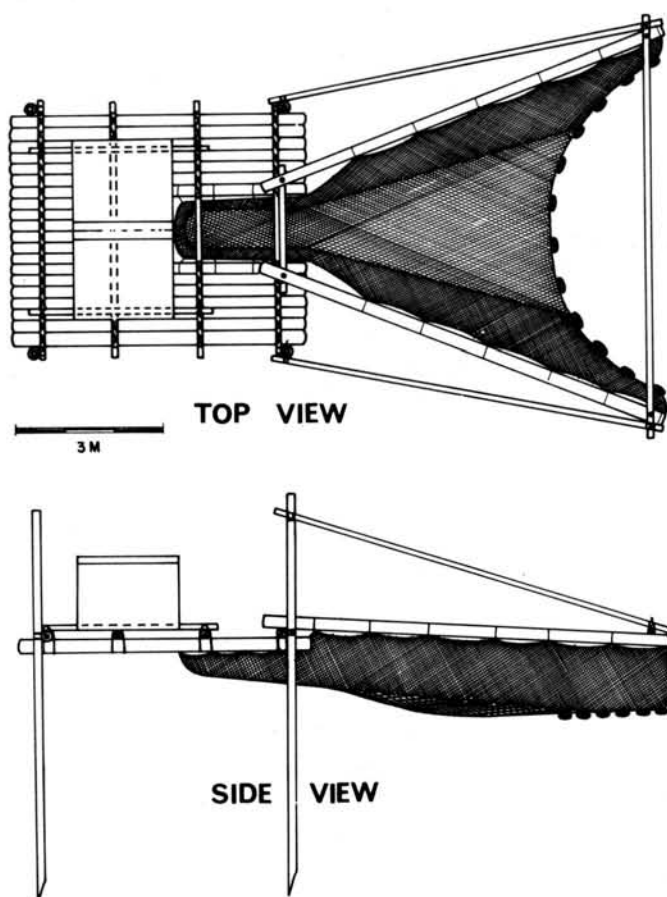

Fig. 5. Capiz patterned fry filter net.

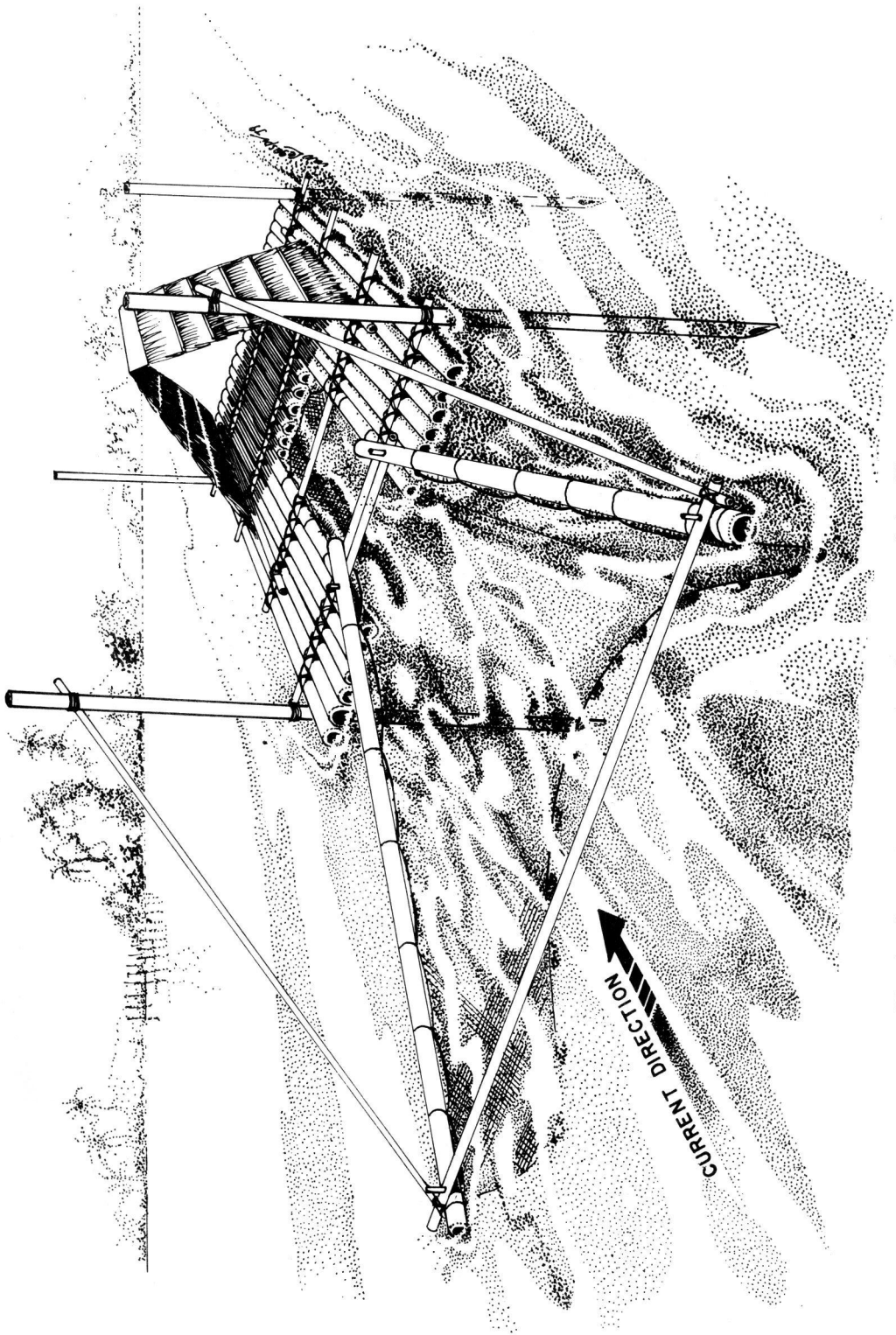

Fig. 6. Operational view of Capiz patterned fry filter net.

4. Fry raft (Figs. 7-10)

The fry raft locally known as "saplad" consists of a long raft made of several pieces of big bamboos made into a guiding net and a codend both made of synthetic materials.

This gear is principally the same as the "Capiz patterned filter net" in operation, and is used in collecting fry migrating with incoming tidal currents at/or near the mouth of brackishwater rivers.

There are some differences between the two, however: i) The fry raft is moored at the river bank, thus the operator can take a rest at home or on land anytime he wants between harvesting periods, while the "Capiz patterned filter net" is equipped with a nipa hut where the fishermen can rest without going back to land; ii) With the fry raft, the fry are guided by means of the guiding net which has a depth of only about 20 cm with bottom parts found only at the collecting portion, while the "Capiz patterned filter net" uses an entirely enclosed guiding net with a semi-circular section.

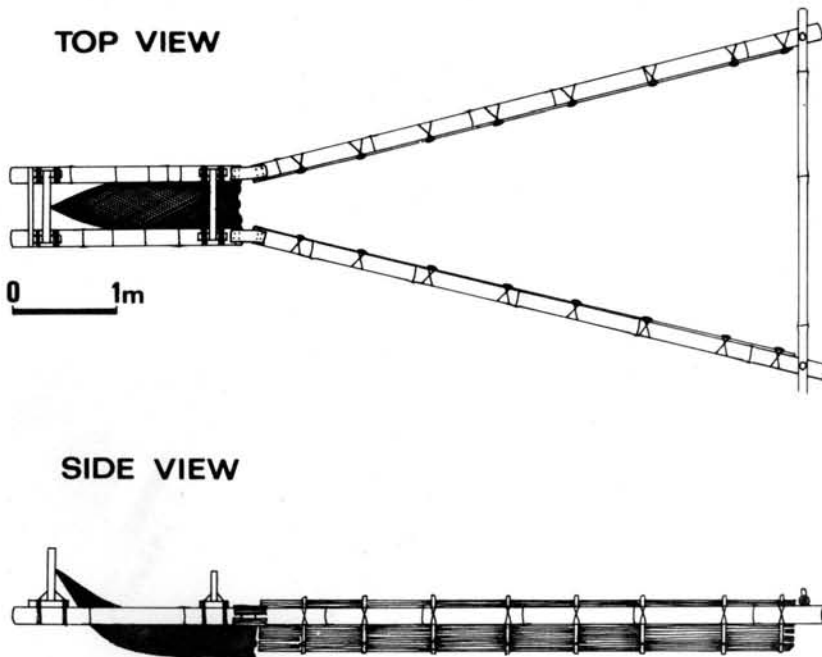

Fig. 7. Fry raft used along shore waters during daytime.

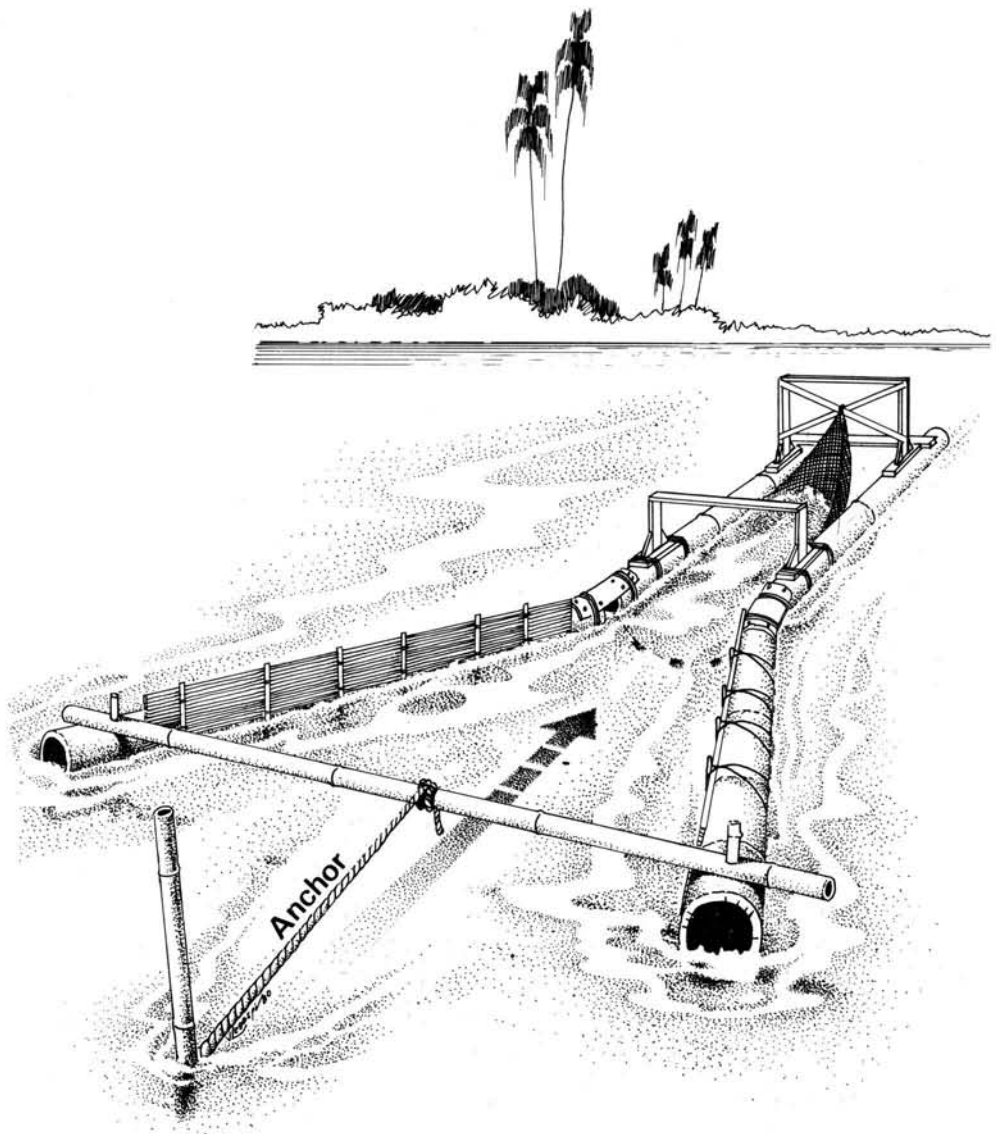

Fig. 8. Operational view of fry raft used at mangrove canals.

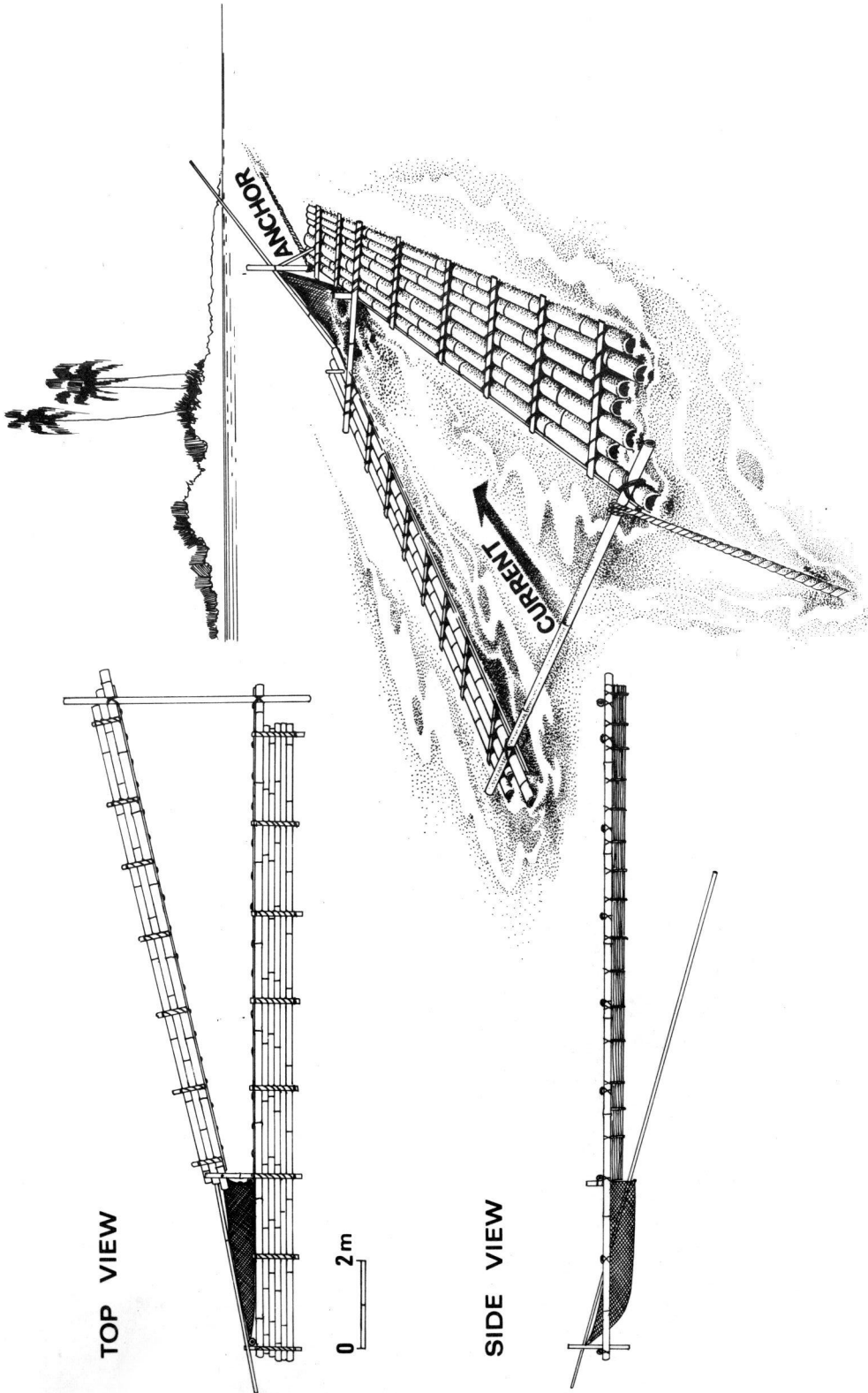

Fig. 9. Fry raft used at the mouth of brackish river.

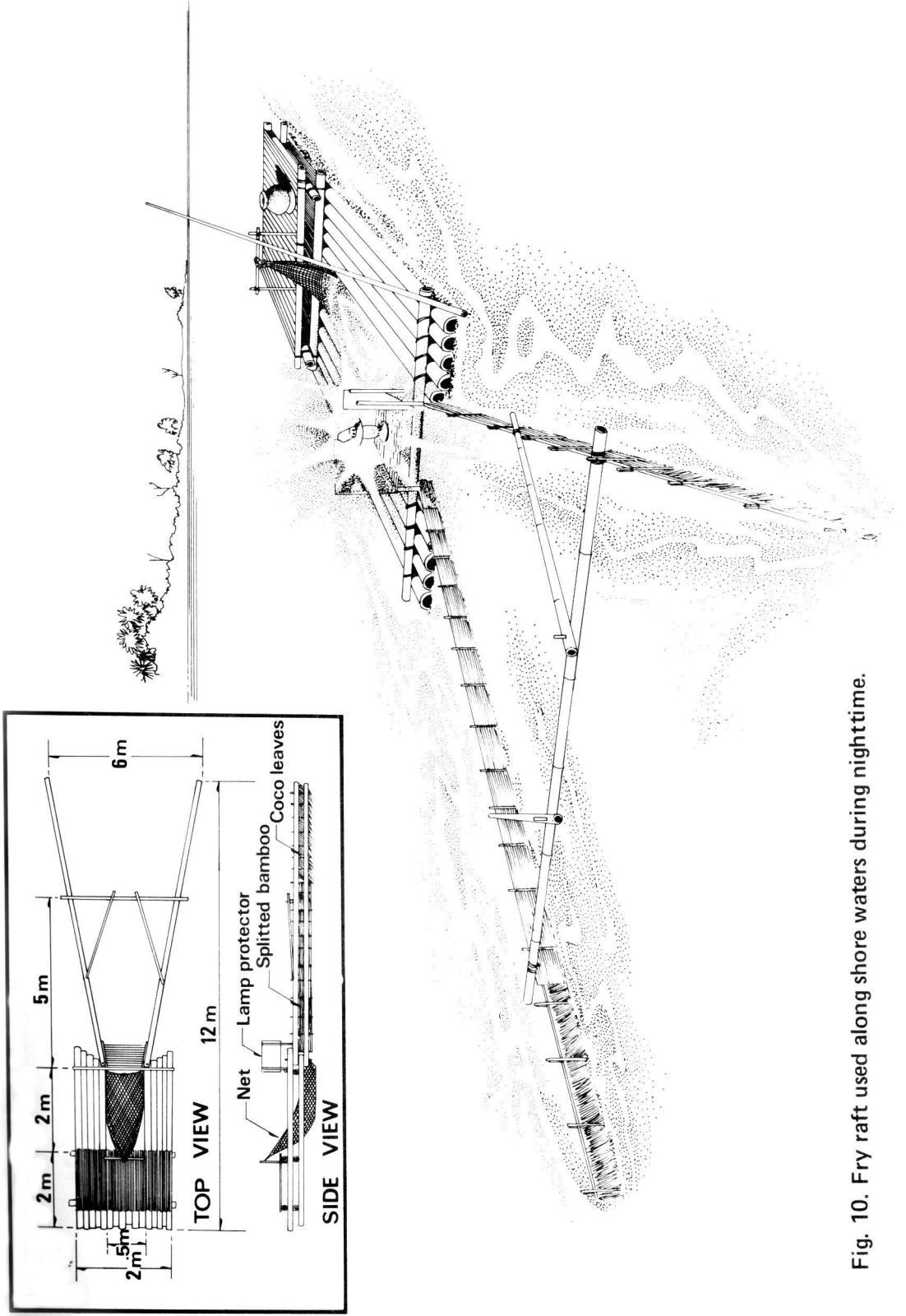

Fig. 10. Fry raft used along shore waters during nighttime.

B. Mobile gear

5. Fry Seine (Fig. 11)

The fry seine, locally called "sabay," "sagap," "sayod," "suyod" or "sibut-sibot" is a kind of small hand net, dimensions of 3 to 6 m long and 1 m wide. The net is made of finely woven abaca cloth or "sinamay". The upper and lower edges are attached to a stout abaca rope for holding. There are neither weights nor floats, so that either cord may serve as the bottom line. However, a modified fry seine with lead weights on one edge and rubber floats on the other is also used. The "sagap" is operated in shore waters up to waist depth, along the sandy beach by two persons holding opposite sides and dragging the net slowly, sometimes bending their waist parallel to the shore. The upper border of the net is usually kept slightly above the water surface. The sugpo fry inhabit the shore waters, probably seeking brackish-water, thus this kind of collecting method is useful.

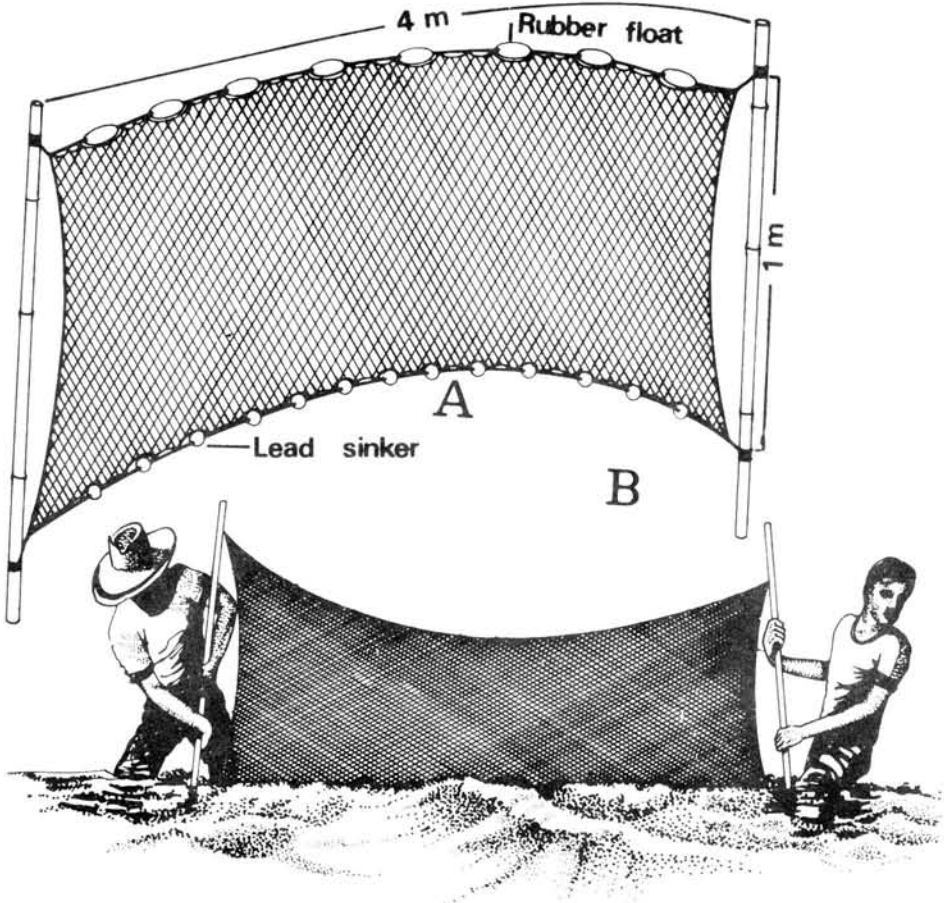

Fig. 11. Fry seine (A) and operational view (B).

6. Triangular or scissors net (Fig.12)

The triangular net, locally called "sakag" or "hudhud", consists of a flattened conical bag made of fine-meshed (about 0.9 mm) sinamay or salap netting (cloth woven from the fiber of Manila hemp) and two pieces of bamboo poles with a wooden or bamboo shoe at each end. The length of the net is about 5.5 m from mouth to codend with local variations. A wooden nail or peg connects the poles at their intersection and allows them to be worked in a scissor-like manner. The proximal portions from the pivot serve as handles for the operator. A modified version is equipped with a semi-circular wooden plate for pushing. The distal end of each pole is equipped with a runner or shoe which is adz-shaped and made of curved wood or the proximal portion of a big bamboo, about 30 cm long.

The triangular net, a sweeping type gear, is operated as a large scoop net by a person wading in waist deep water, parallel to the shoreline.

It is called a triangular or scissors net because it forms a triangle and looks like a pair of scissors.

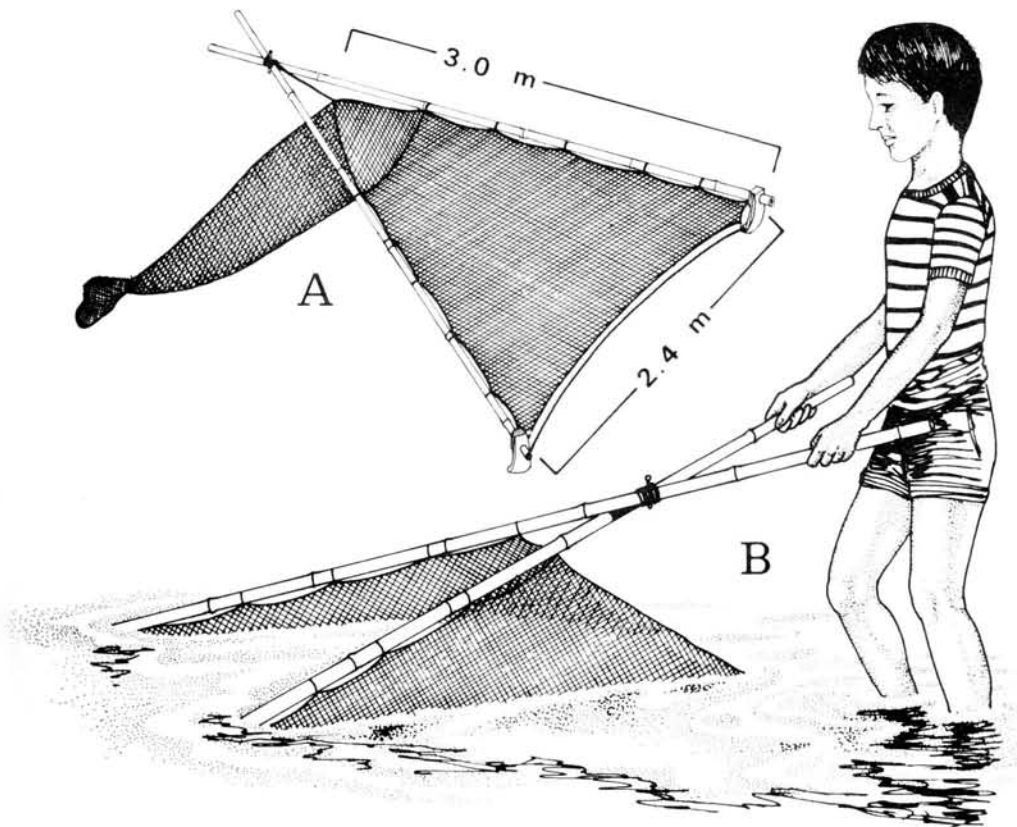

Fig. 12. Triangular net (A) and operational view (B).

7. Fry bulldozer or fry dozer (Figs. 13-14)

The fry bulldozer or dozer, locally called "baka-baka" or "traveller", is made of several bamboo poles which serve as frames and floats, with mesh size of 0.9 mm made of sinamay or synthetic netting and several stone or lead sinkers. It is triangular or trapezoidal in shape. The dimensions are usually 210 cm wide in front, 76 cm wide at the rear, and 300 cm long. The width of wing net is up to 15 cm, while the length is sometimes 5 m. The fry dozer, which is a floating type, is operated by one or two persons pushing it parallel to the sandy shore. The manner of construction as well as the size varies according to locality. Unlike the sweeping nets such as the triangular net, the fry dozer has a relatively poor catch per unit effort, because the prawn fry mostly dwell at or near the bottom, particularly during daytime. The fry dozer is more efficient for collecting finfish fry like "bangos" (*Chanos chanos*).

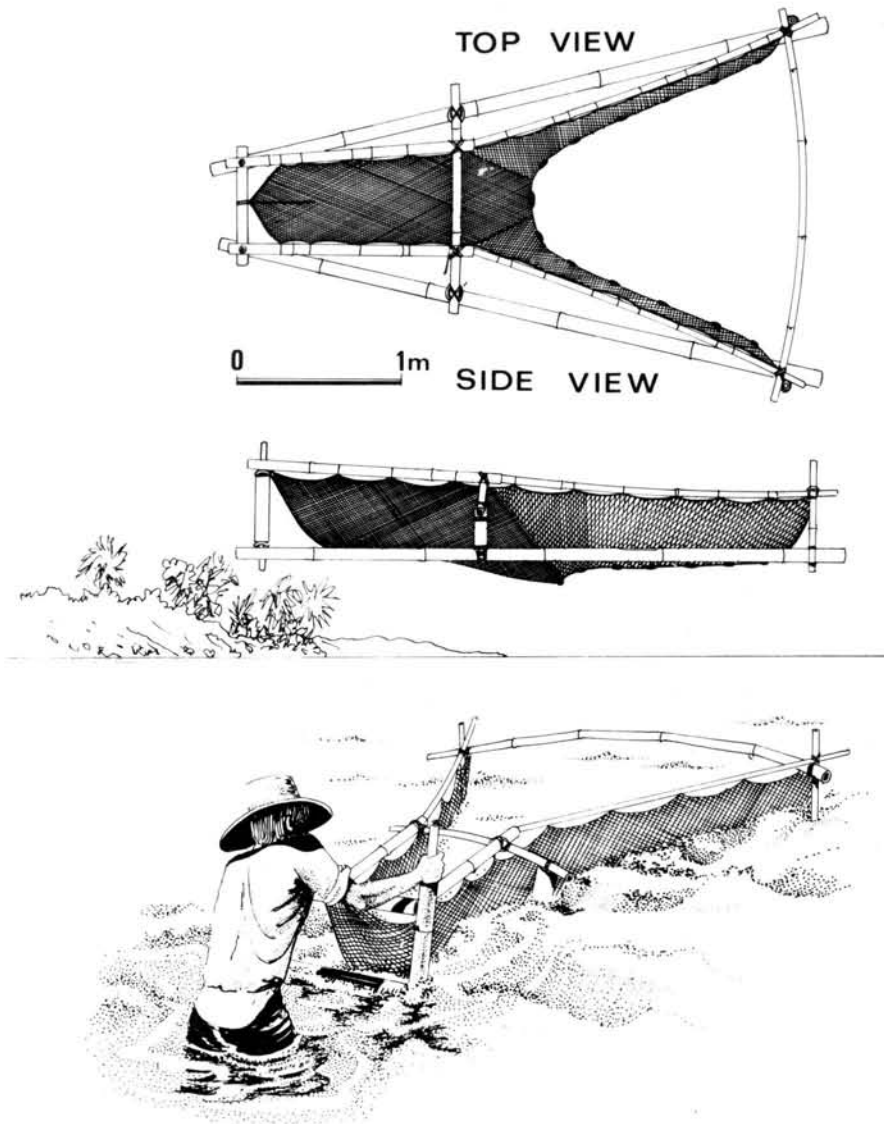

Fig. 13. Fry bulldozer operated at shore waters by one person.

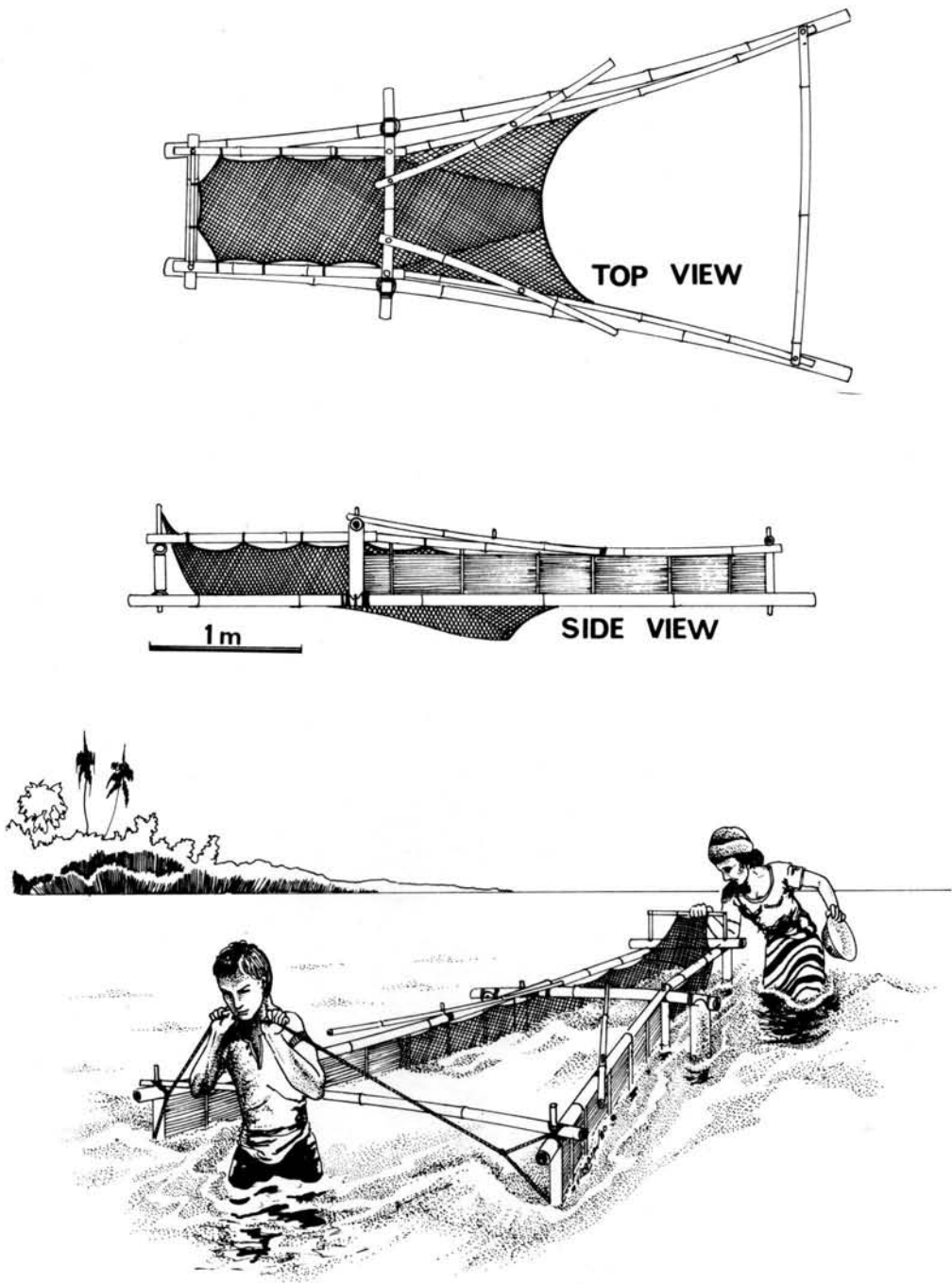

Fig. 14. Fry bulldozer operated by two persons. Dimensions are also indicated

8. Fry scare line (Fig. 15)

The fry scare line, locally called "surambaw" consists of one scoop net and a long scare line carrying streamers of coconut leaves. The scare line is from 30 to 50 m long and is operated by two fishermen. This contrivance is used in shallow waters, along the shore and over sand bars. In fact, this device is more effective for catching bangos fry than sugpo because it sweeps only near the surface layer of the water down to 20 cm deep.

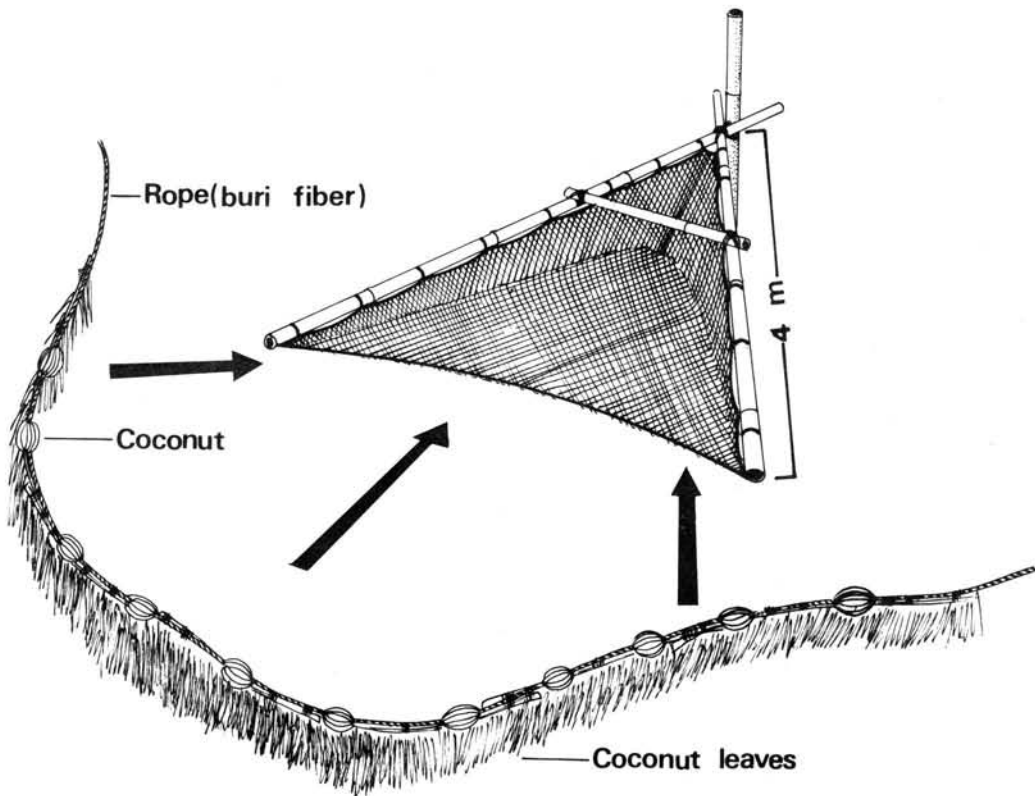

Fig. 15. Fry scare line. Operational movement shown.

9. Scoop net (Fig. 16)

The scoop net varies in type from place to place and is also utilized to collect fry hiding or clinging to mangrove roots, water grass or other objects in brackish-water areas.

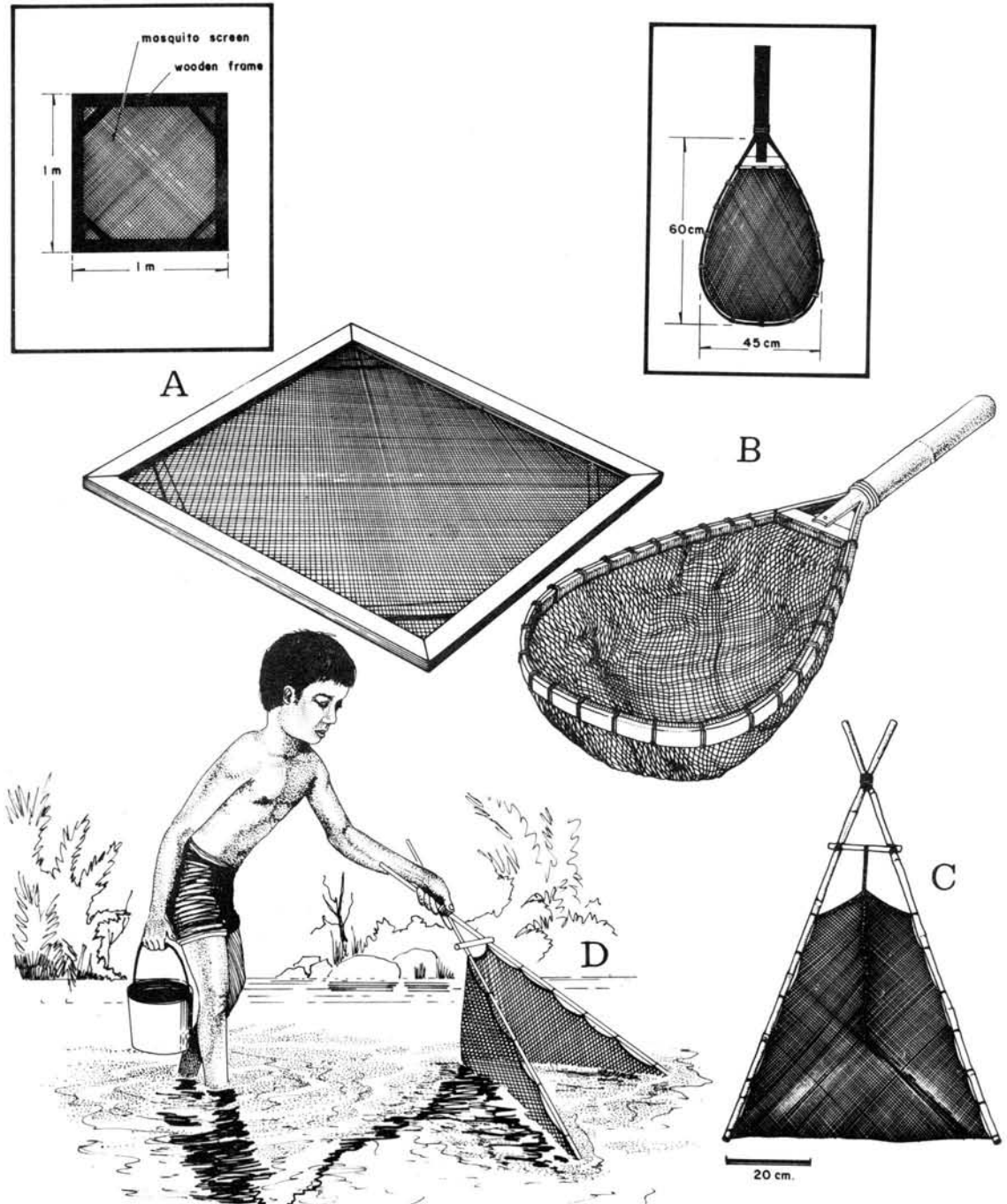

Fig. 16. Three types of scoop net (A-C) and (D) operational view.

II. Gear for adult prawn and shrimp

A. Set impounding net

1. Fish corral (Figs. 17, 18)

The fish corral locally known as "baklad", "taba", or "tower" consists of guide lines and a codend. The guidelines are made of bamboo poles, wooden poles or split coconut trunks while the codend is made of split bamboo known as "banata", or synthetic netting. Harvesting is done during low tide, usually in the early morning. At present, there are three kinds of fish corrals in use. One is used for gathering the fish and prawns to a permanent terminal compartment or codend. To catch the shrimp one of the fishermen goes inside the codend through a narrow channel leading to a guiding wall, and dives under the water with a spear or scoop net.

The second type is equipped with a detachable circular codend which is lifted elevator-like by four ropes with the aid of pulleys. After harvesting it is lowered into the water and one fisherman unties the entrance of the codend. A terminal compartment made of a square or a rectangular cage approximately 1.5 m tall is lifted to the surface by four ropes attached to its corners and wound around a perpendicular piece of bamboo which is rotated along a pair of parallel bamboo bars like a winch. A man gets inside the cage through a hatch to collect the fish. After harvest, the cage is lowered and reattached to the narrow end of the guide net.

The third type is located in shallower areas. The cage is merely detached and carried to the shore by two to four men and then replaced after harvest. Fish corrals located inside the bay, river mouth and mangrove area are smaller, while those facing the open sea are larger in construction.

When almost adult, the prawn and shrimp migrate from shallow nursery areas to the open sea for mating and spawning. During this time they are mostly trapped by the fish corrals particularly during nighttime.

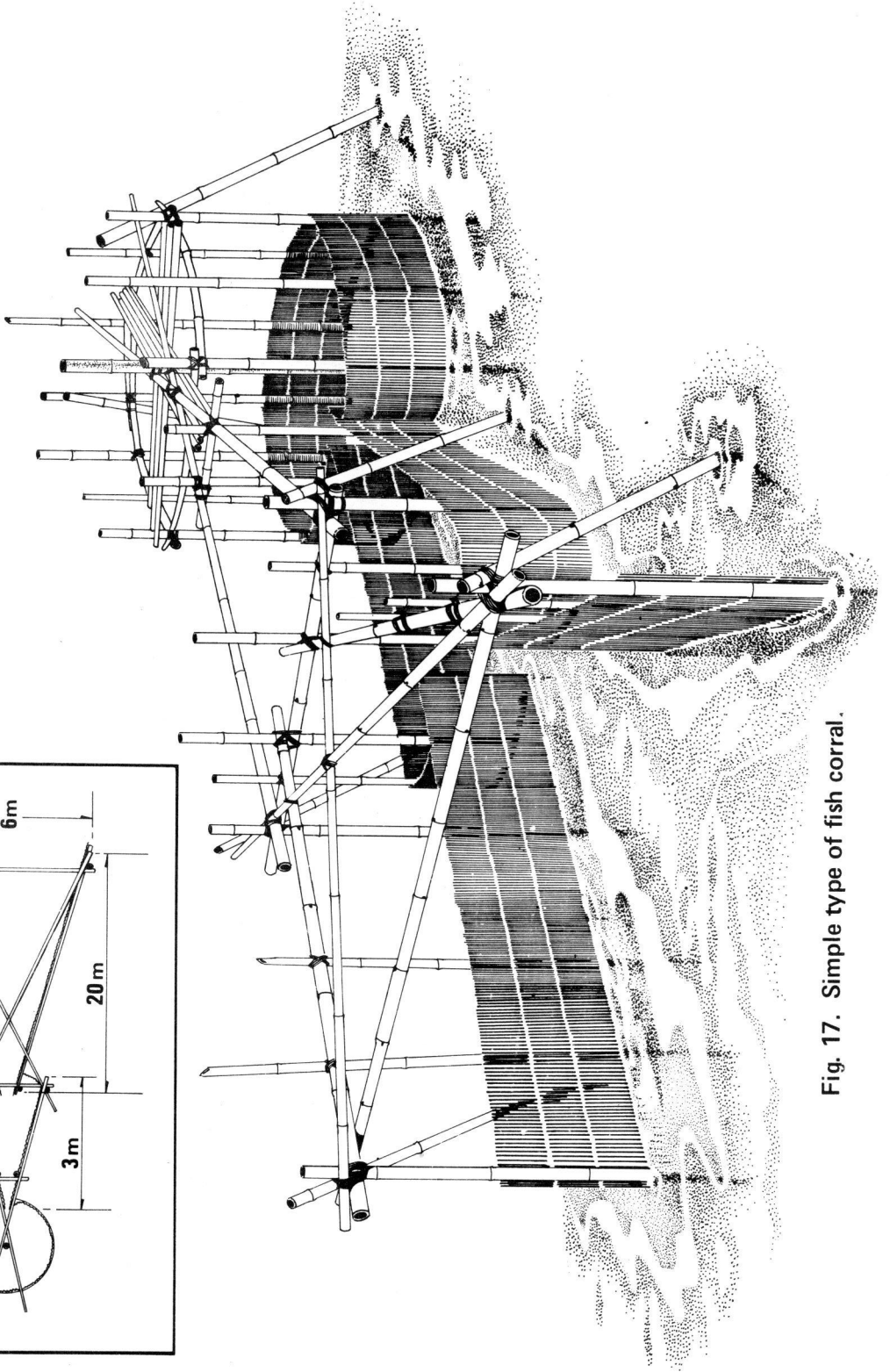
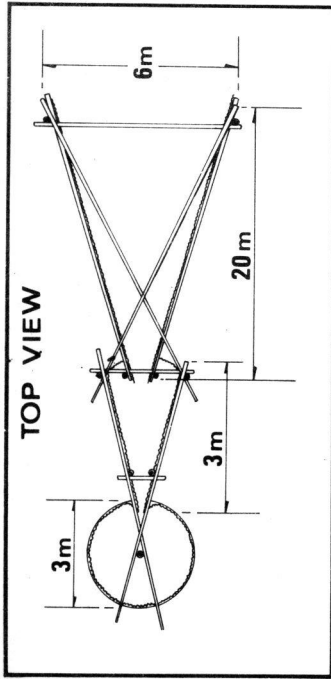

Fig. 17. Simple type of fish corral.

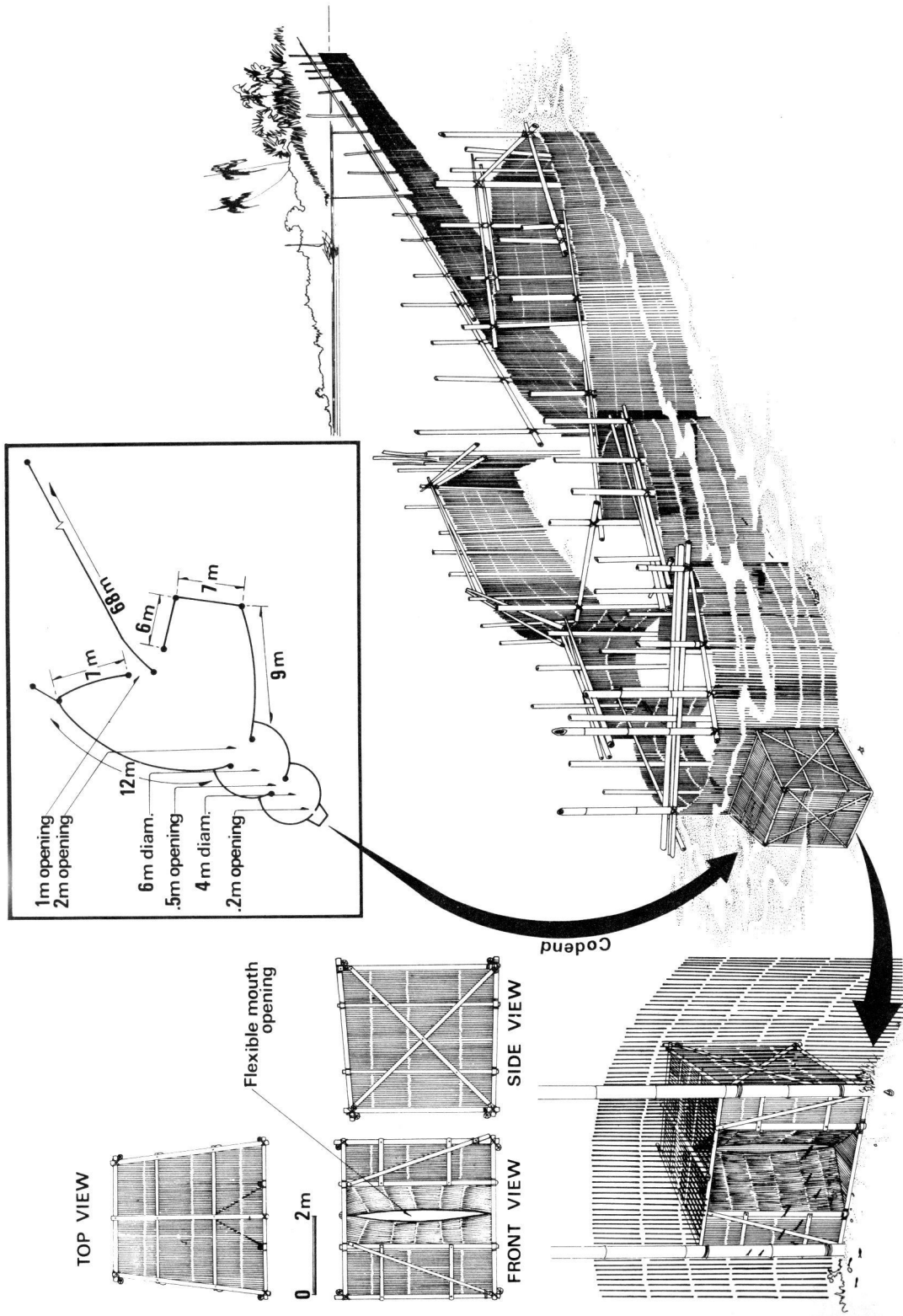

Fig. 18. Fish corral with detachable codend.

2. Prawn trap (Fig. 19)

The prawn trap consists of bamboo or split coconut trunk for support, bamboo matting or "banata" as a guide screen or leader, and one codend as a catching chamber.

The bamboo screen leads the prawns to a codend, located diagonally from the fishpond dike. The construction is basically the same as the fish corral, however, the bamboo screen of the trap is generally not so long, usually less than 5 m, situated in narrow mangrove channels, creeks and inside or outside fishponds. Above the catching chamber there is a small nipa hut used as a resting place as well as a guard house at night.

It has no detachable codend, thus the harvest is usually made by means of a scoop net.

According to Delmendo and Rabanal (1973), prawn traps are locally called "bakikong", "paabang", and "aguila" based on their construction and location. Basically, the construction as well as the manner of operation is similar to the fish corrals. According to a caretaker of a prawn pond, the harvest is made at night during floodtide, as the prawn move towards the prawn trap, due probably to their search for fresh seawater.

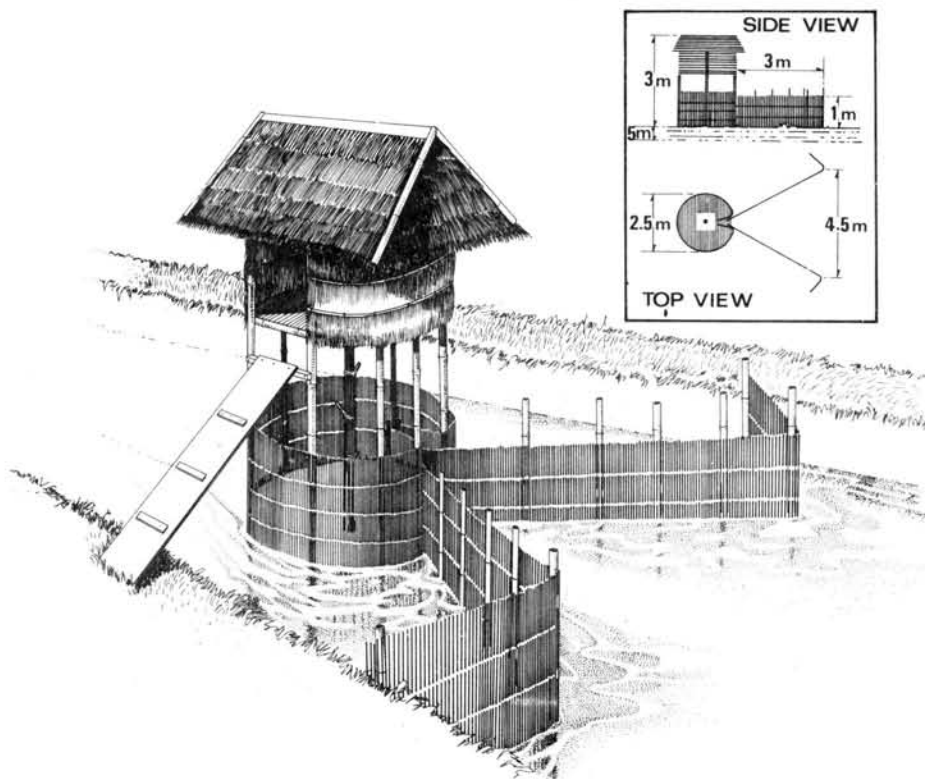

Fig. 19. Prawn trap.

3. Filter net (Figs. 20-21)

The filter net is locally called "saluran", "sangab" or "taan"

Construction materials for the filter net are coconut trunks for the posts, bamboo matting for the guide lines and synthetic nets for the codend. The filter nets are seldom constructed singly and are usually joined in series across a river mouth or shallow channel. A V-shaped leader is used to guide the fishes into a conical net bag which is set when the water is receding and usually faces upriver. A few filter nets "saluran" are constructed with opposing V-shaped leader and can be operated during ebb and flood tides.

The net is supported on rattan loops which slide down a pair of perpendicular bamboo poles positioned at the inner end of the leaders. The net can be raised or lowered. The length of the net is usually 8 to 10 m but varies according to location.

Harvest is done once or twice daily during a particular tide by reversing the setting operation. The gear is normally operated at night but may be operated during the day when the water is turbid, especially on rainy days. This gear operates on the principle of filtering fishes and shrimps suspended in the water when they are partially disoriented by the water current and when they are migrating towards open sea.

The "bukatot", "diakos" and "saplad" (Domantay, 1973) are modified filter nets set against the current inside tidal creeks, river mouths, or mangrove swamps.

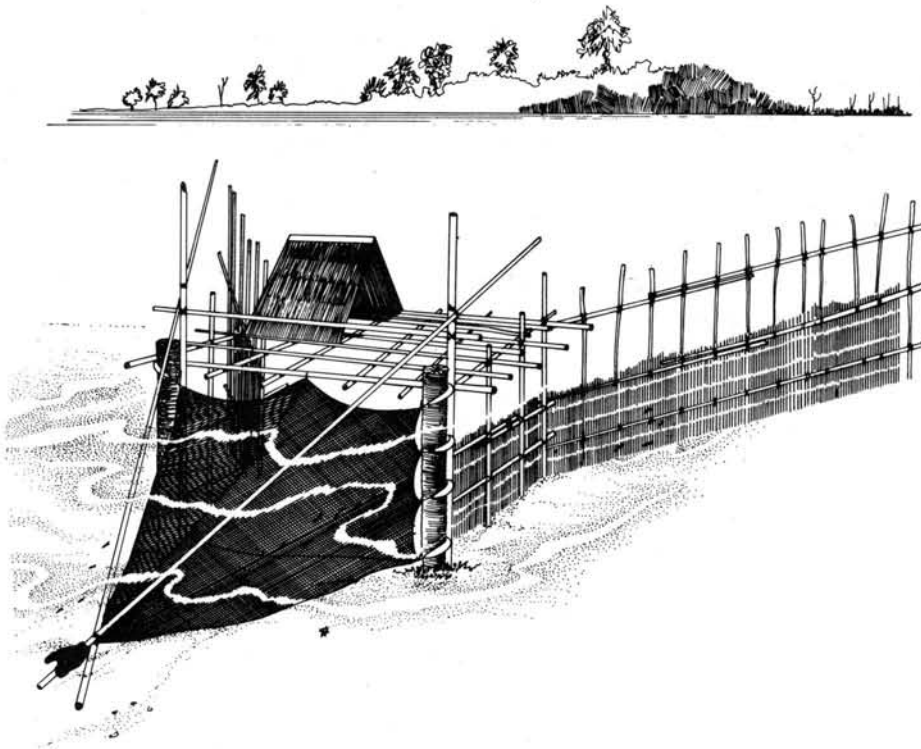

Fig. 20. Operational view of filter net.

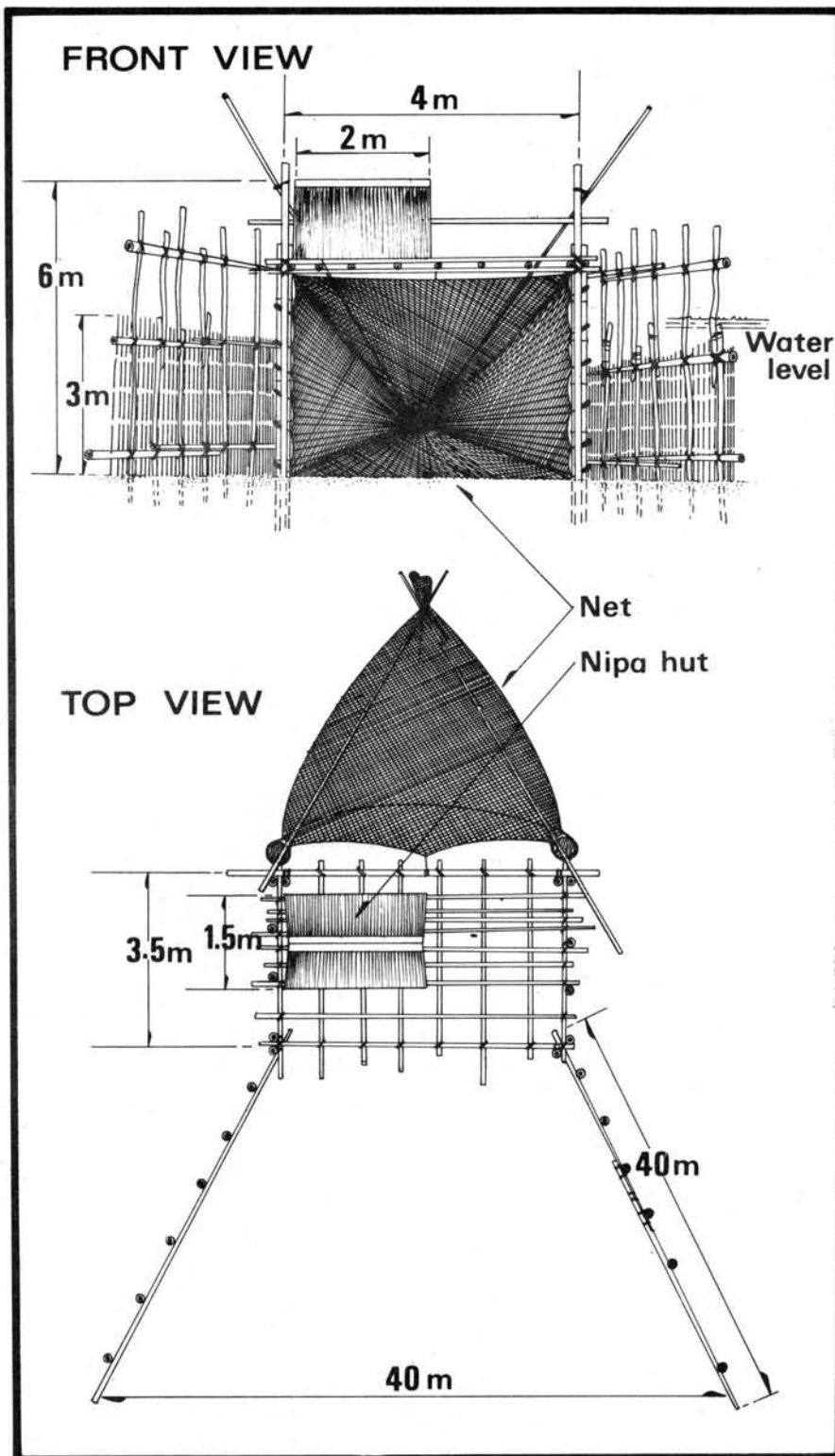

Fig. 21. Dimensions of filter net .

4. Lift net (Figs. 22-23)

This gear locally called "bantahan" or "sumbadahan" does not depend on the current and in fact should not be located where there are strong currents.

A square platform raised about 0.5 m above the highest tide and supported by bamboo stakes in the framework is normally employed. Operation is by lowering a weighted square mouthed net, almost as wide as the platform above, to the bottom by an improvised wooden winch. Pulleys are provided at each corner of the platform where a lifting rope is passed through to the corners of the net. While the net is at the bottom under the platform, the fisherman lights a kerosene lamp to attract fishes and shrimps and also to aide his sight. The fish and shrimp are further concentrated below the center of the platform by gradually dimming the light. Hauling is done manually by slowly rotating the winch until the edge of the net surfaces. The catch is concentrated in the center and scooped by a long handled scoop net operated from the platform. Several hauls may be made at night depending on the abundance of fish. To counteract the net overturning due to currents, stones are attached to the corners of the net to keep it in shape. The sag at the center of the net should not be less than 1.5 m for more effective catching. Sometimes the fishermen spread baits, viz. raw, salted and sun dried trash fish inside the net. At night prawns seek for food and are attracted by the light, thus the lift net is effective for their capture.

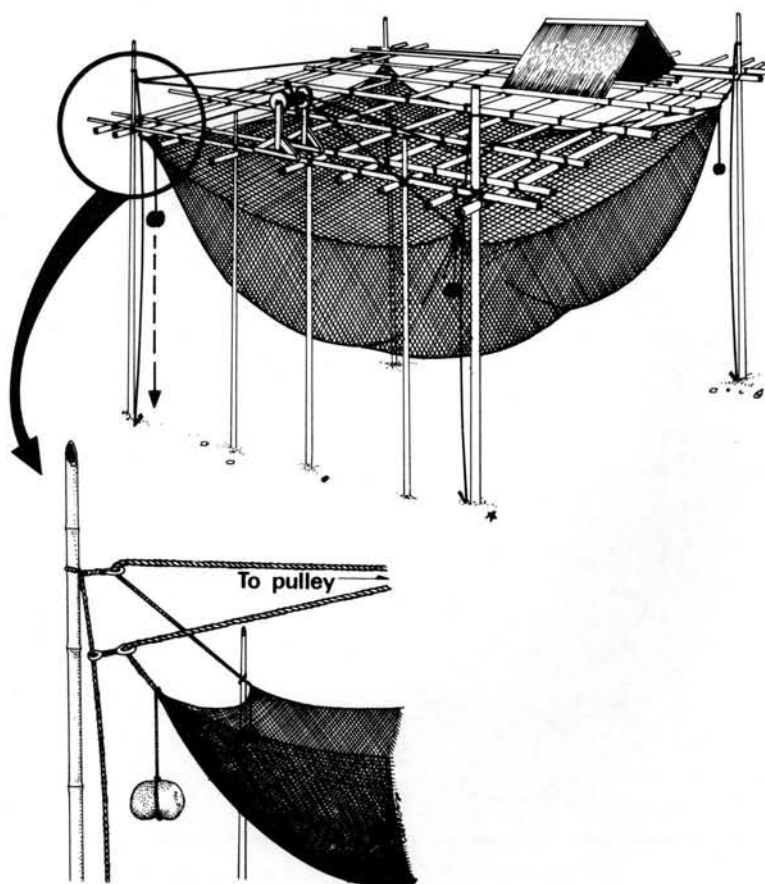

Fig. 22. Operational view of lift net.

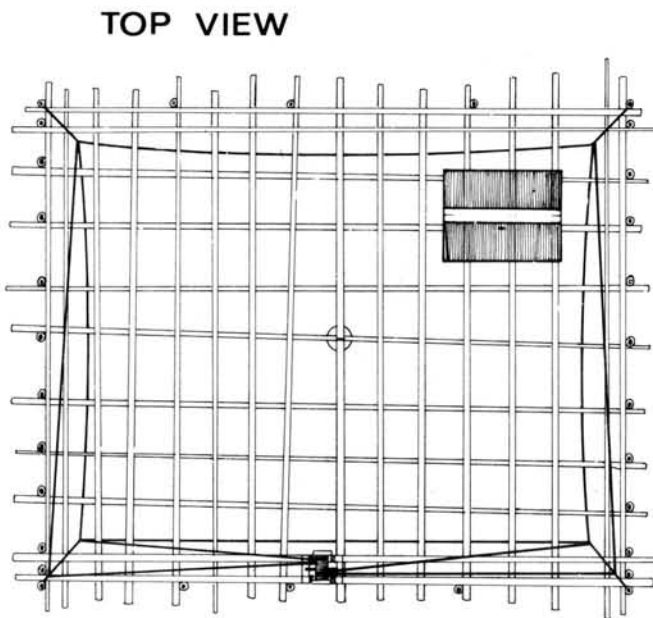
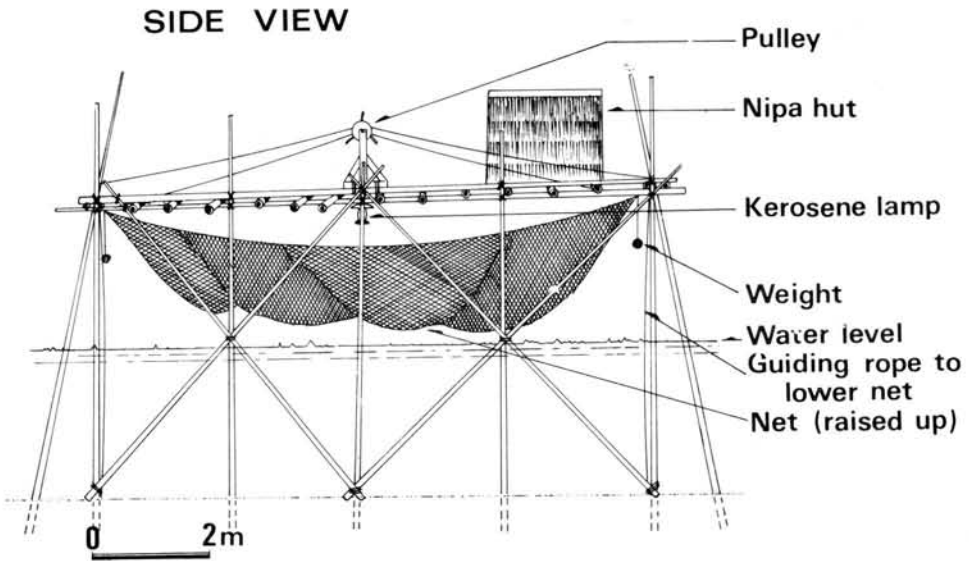

Fig. 23. Side and top views of lift net.

5. Lever net (Figs. 24-25)

Locally known as "salambaw", its operation is similar to the lift net, but the gear is mobile since it is operated from a bamboo raft. The net framing is made of strong cruved bamboo poles forming half or quarter circles tied centrally across each other from whose tips the four corners of a concave net are suspended. The frame and net are hung from the terminal of a bipod boom extending from one end of the raft, providing ample space for the frame and net to be submerged. In operation, the raft is anchored, then the boom is lowered from an angle of about 70 degrees to a lesser angle by reducing the counter weight of stones or rocks on a plank lever made of bamboo or wood tied to the raft, until the net is finally submerged. During lowering of the boom, the control rope is carefully released while the weights are removed. There must be enough stones to raise the boom back. To haul, the procedure is reversed. The catch is scooped by a long handled scoop net. Like other night operated gears, light is used to attract fishes. To transfer from one fishing area to another, it is moved by poling and at times it may also be pulled by motor boat. The efficacy of this gear is due to prawns being nocturnal and attracted by light, similar to the lift net.

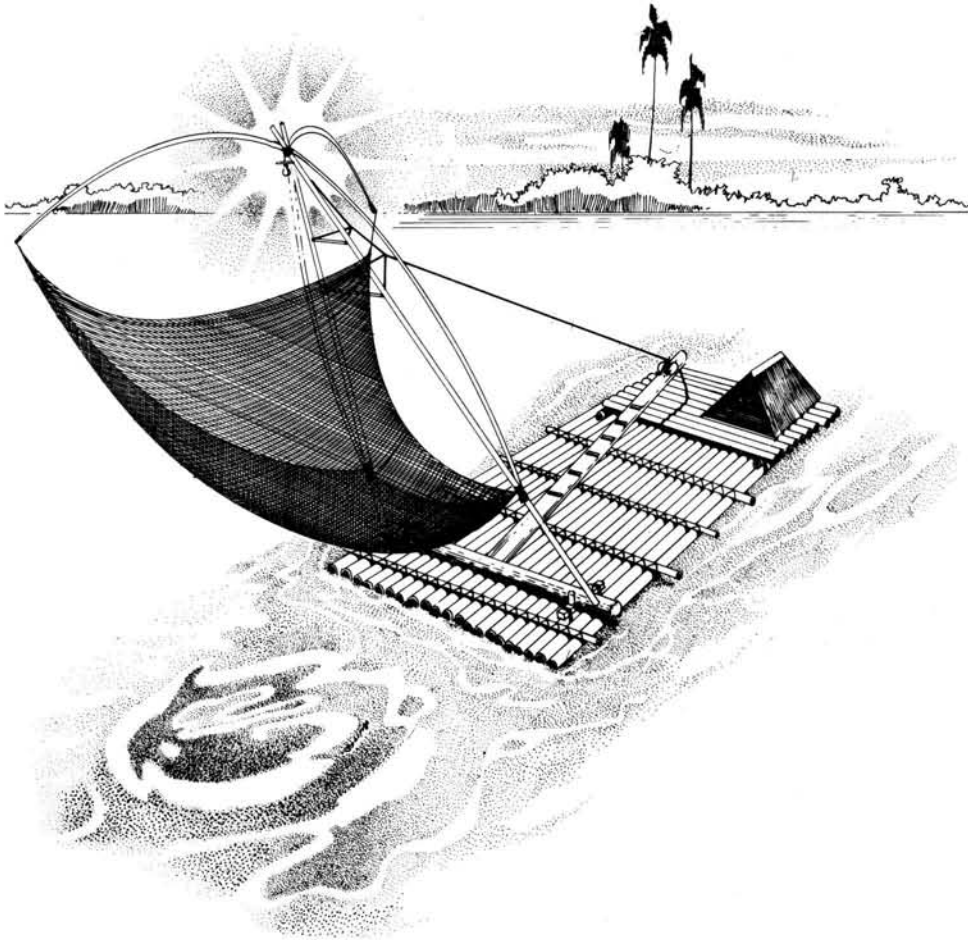

Fig. 24. Operational view of lever net.

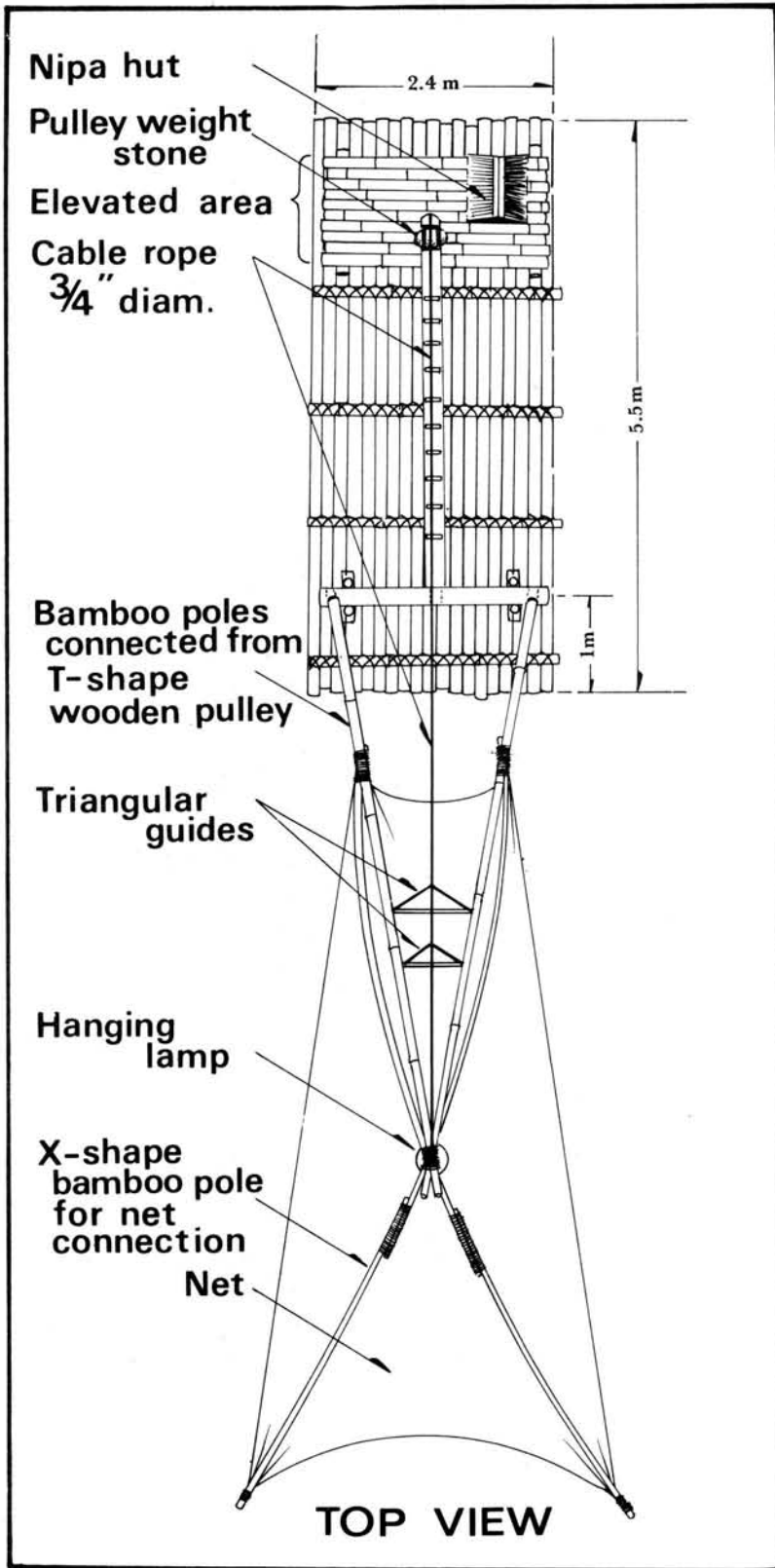

Fig. 25. Construction of lever net.

6. Cover net (Fig. 26)

This is a circular-type net with a long bamboo handle, locally called "pingpong". At night, usually during low tide, a fisherman walks along the shoreline or mangrove creek with a kerosene lamp and when he finds a prawn, suddenly covers it with this net and then grasps it with his other hand. If he can use a banca, he can catch prawns in deeper waters. The kerosene light not only guides the fisherman, but also attracts the prawns. When attracted by light, the prawns move slowly therefore they are easily captured even by hand.

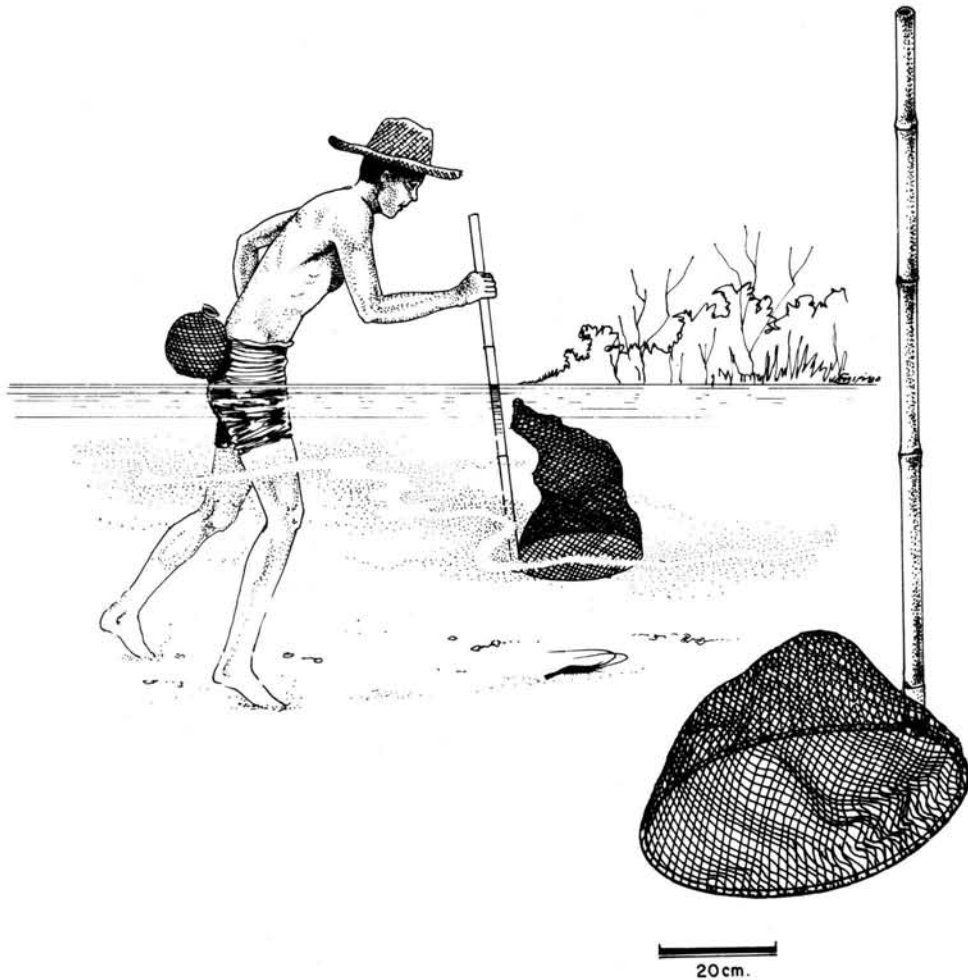

Fig. 26. Cover net "pingpong".

B. Mobile impounding nets

7. Cast net (Fig. 27)

Capture with a cast net is an unusual method and the harvests are limited due to the small size of the net. It forms a circular outline, with a leadline at the circumference of the net. The operation requires a well-studied technique. The net is fully folded partly over the left arm and held by the right hand, the hauling line is arranged on the ground. Casting causes the weighted circumference to spread so that the fully extended net covers the water. After hitting the water surface the leadline sinks down quickly, thus encircling all swimming animals directly below the net to the bottom. The cast net, locally called "laya" is mainly employed in still, shallow coastal waters. When the net sinks in the water, prawns move towards the center of the net by the leadline.



Fig. 27. Operational view of cast net "laya".

8. Triangular net (Fig. 28)

The triangular net, locally called "hudhud", is also called push net or scissors net because of its method of operation and shape.

It is operated by one man wading chest deep in mangrove creeks, brackish rivers, and in shore waters where sometimes a great number of *Acetes* sp. (small primitive shrimp), locally called "hipon" or "alamang", can be caught. It consists of two bamboo poles and a mosquito net made of synthetic nylon. There is only a slight difference in construction between this gear and another type of triangular net used for collecting sugpo fry: the former has larger shoes at the distal end of the bamboo pole, as it is usually operated in muddy areas. The triangular net is operated at dusk or night when shrimps are moving around on the muddy bottom.

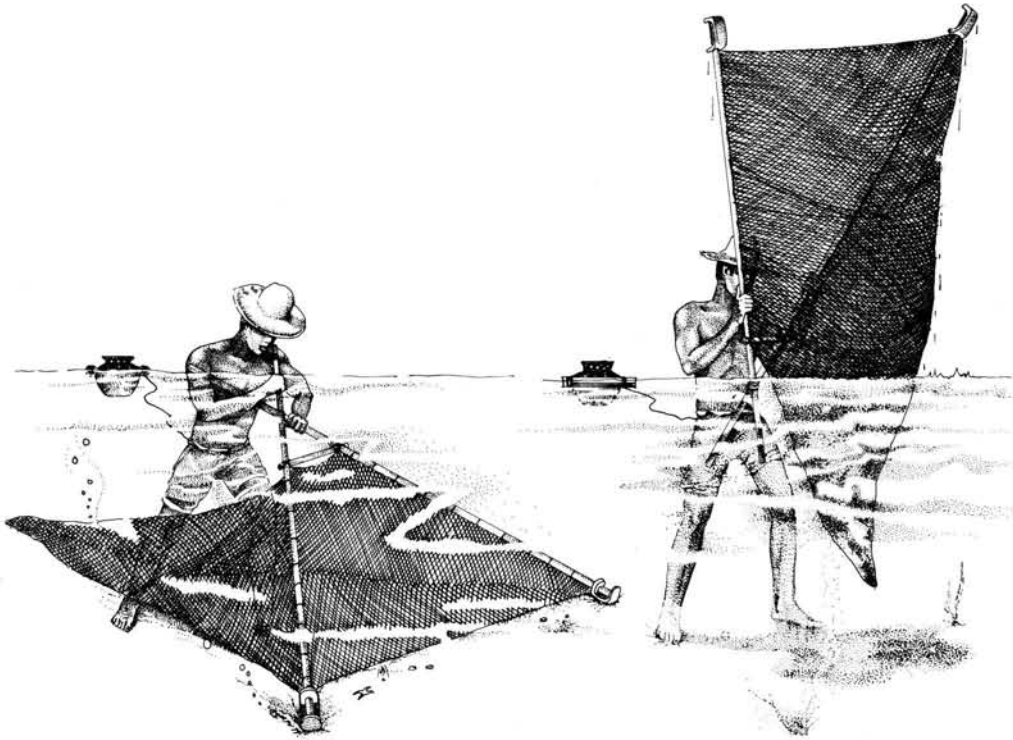

Fig. 28. Operational views of triangular net "hudhud" (slightly modified from Umali, 1950).

9. Beach seine (Fig. 29)

The beach seine consists of paired wing nets, 2 ropes usually 300 m, and a codend. It is cast along the sandy beach leading offshore and ends at the beach in a semi circle, then pulled toward the sandy beach by more than ten people. More prawns can be captured at night, as they are nocturnal.

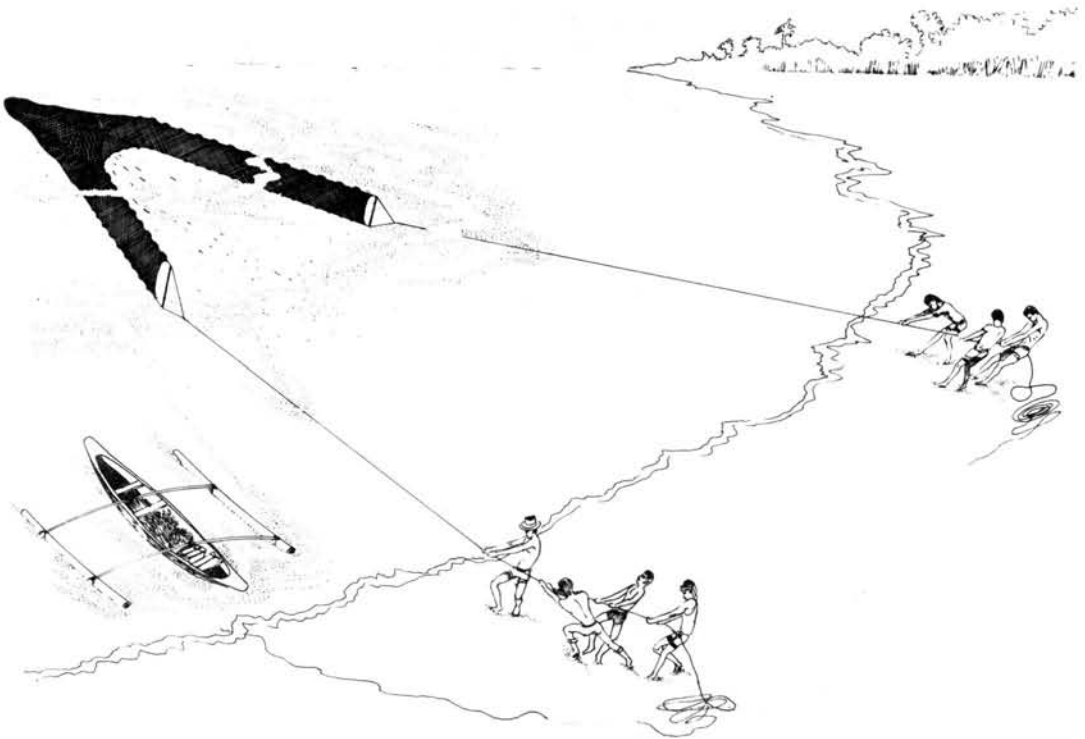

Fig. 29. Operational view of beach seine.

10. Skimming net (Figs. 30-31)

The area available for the operation of skimming nets is covered by municipal ordinance and is limited to the shallow interior portion of bays.

The apparatus comprises a motorized boat, usually operated by 2 men with a single piston engine of up to 10 horsepowers, a triangular net, a V-shaped bipod frame and a kerosene lamp. The frame is made of a pair of 8 bamboo poles bolted on one end, with both free ends provided with wooden flat shoes so they can glide over the mud bottom when set on a slightly inclined position. The net is tied to a frame that is securely attached to the bow of the boat. As the boat moves forward, the net is set in place almost directly under the boat with the codend just a meter or more ahead of the screw. The whole width of the frame spread in front of the net opening is provided with a scare leadline. To make a haul, the boat is stopped and the codend is lifted and its contents emptied into a sorting box. A kerosene lamp is normally tied to the front of the boat to attract fishes and shrimps and also as a navigational aid. Operation is further enhanced when the water is turbid. The skimming net is effective since the net is located in front of the boat, minimizing the disturbance to the prawn generated by the engine noise and screw compared with a baby trawler.

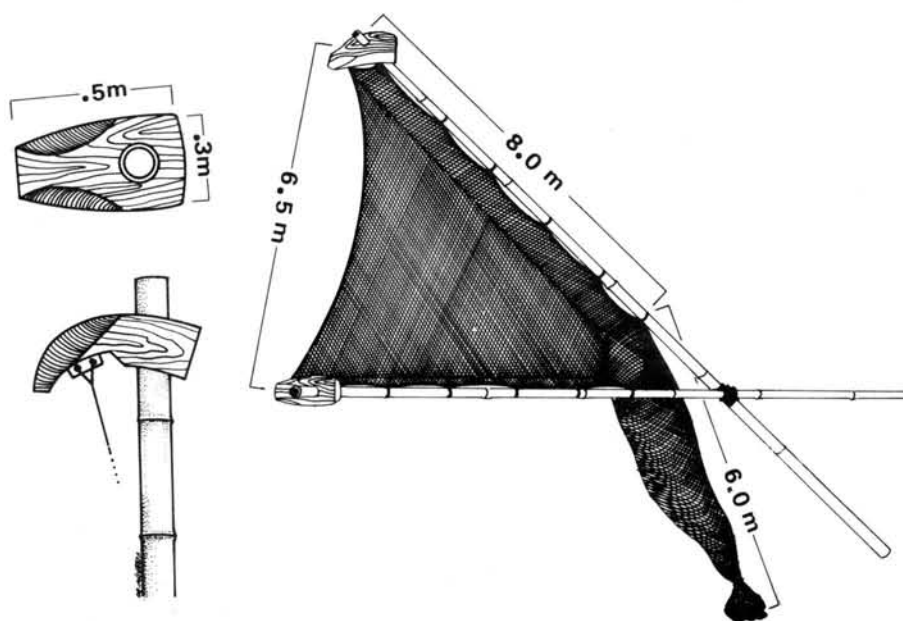

Fig. 30. Dimensions of skimming net and its shoe.

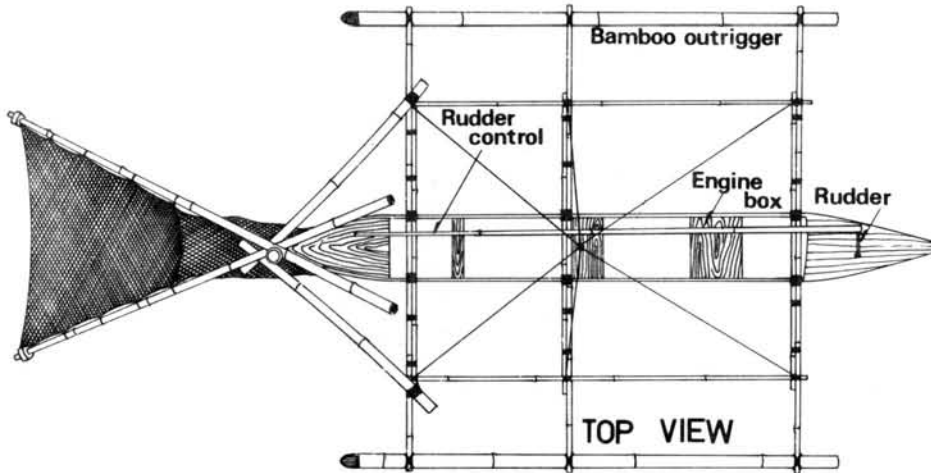
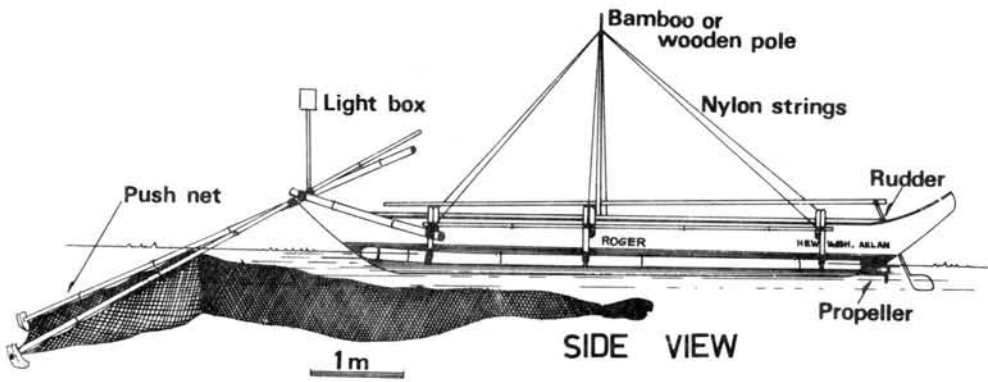

Fig. 31. Semi-operational view of skimming net attached to motorized boat.

11. Baby trawler (Fig.32)

A baby trawler normally consists of a motorized boat which is the same type for a skimming net (Fig. 31), towlines, otter boards, buoy and lead sinker, and a trawl net. Prior to fishing, the towlines up to the net are assembled. In paying out, the net goes first, along with the sinker and buoy lines while the boat is moving at low speed, then the boards follow and are tested for balance and weight. The towline is paid out slowly to the desired length and secured to a capstan or any strong part of the boat on its aft section. If all is in order, trawling is carried out at a faster fishing speed for 30 minutes or longer. Hauling is done manually by pulling into the boat the towlines until the net and catch are finally recovered. Debris caught in the course of fishing is removed at hauling time. Tears on the net are also checked and sewn. The routine is repeated. Operation normally starts at dusk and ends at dawn as prawns are nocturnal, but may also take place during the daytime in turbid water. Prawns seem to prefer such conditions, probably due to safer conditions from their enemies.

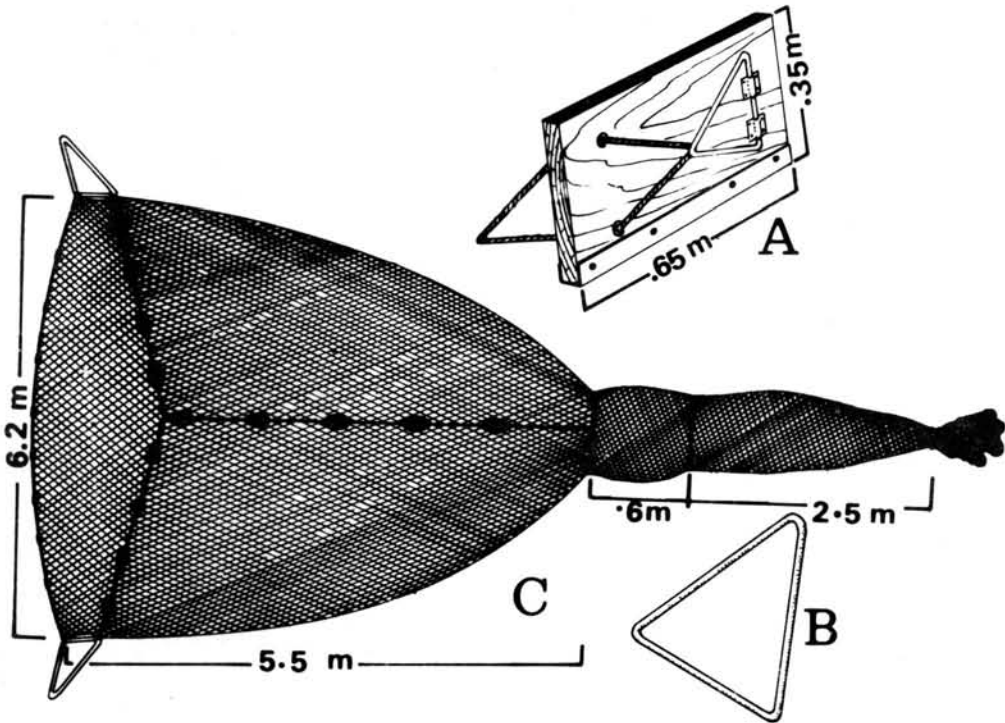

Fig. 32. Otter board (A), iron triangle (B) and net (C) of baby trawler.

12. Otter trawler (Fig. 33)

The otter trawler is operated by professional fishermen in ocean waters to catch not only prawns but also finfish as well as crabs and cuttle fish. The otter trawler has an "otter-board" on each towline to hold the net open while operated by a single boat. The boat is powered by diesel engines ranging from 150 to 500 horsepower. Power winches on trawlers are operated partly by transmission from the main engine and partly by auxiliary engines. Most of the otter trawlers in the Philippines are not equipped with electric refrigerators, freezing units, or cooking facilities, but have crushed ice to maintain the quality of the catch, thus one fishing trip lasts for about five days due to the difficulty in keeping ice. Most of the catch among prawns are "bulik" (*Penaeus semisulcatus*) and "pasayan" (*P. merguensis*) in terms of weight. The vessels for otter trawling are, in many cases, built of wood although there are a few modernized steel vessels in the Philippines. Trawling for prawns is usually done during nighttime because of the prawn's nocturnal behaviour.

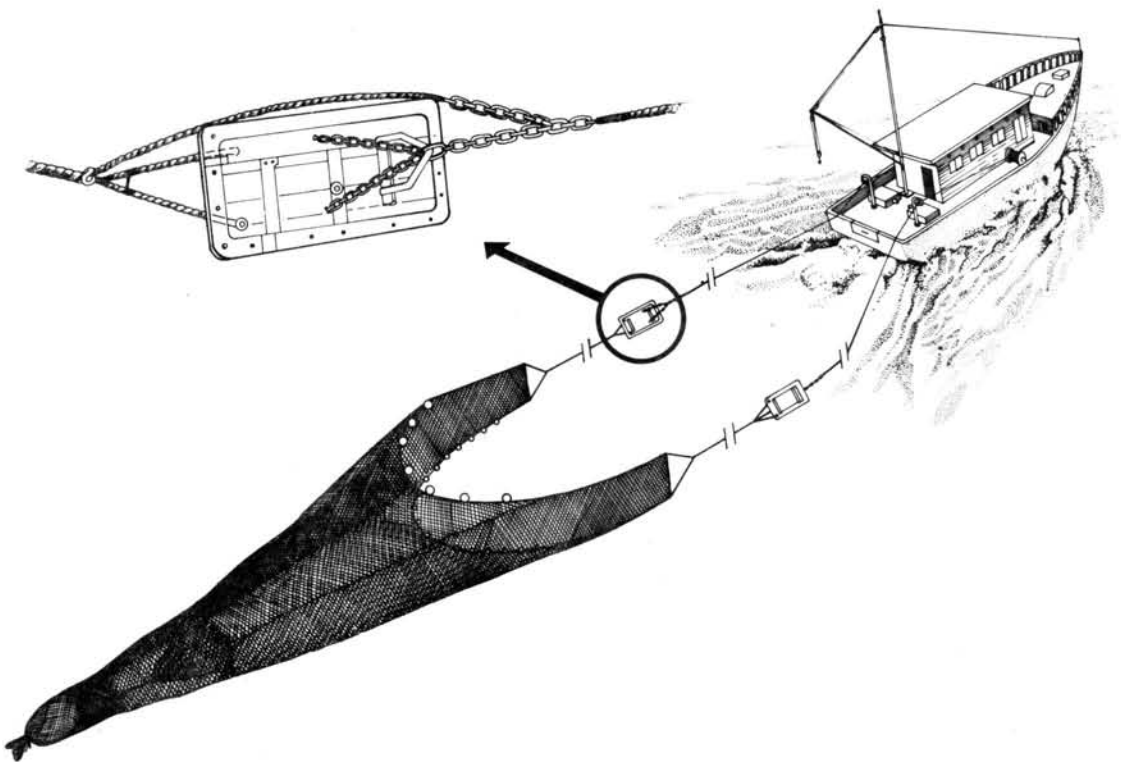

Fig. 33. Operational view of otter trawler.

C. Entangling net

13. Gill net (Fig. 34)

Gill net is composed of a one layer net, cork floats, lead sinkers, both upper and lower ropes, and a pair of buoyed anchors.

The net has a mesh size of 1.5 cm and is made of synthetic fibers. Paulownia or synthetic floats, each 15 cm long, are positioned at intervals of about 60 cm along the upper rope and sinkers weighing 35 g each are arranged 3.5 cm apart from each other along the lower rope. The gill net is usually spread out in a straight line, fixed on the bottom by anchors. The "pante" or "panti" is one type of gill net used for catching shrimps and crabs. Its construction is almost the same as the ordinary gill net.

The "panti" is laid out in a semi-circle, starting from a buoyed anchor with the aid of a motorized banca. After paying out the net, the banca is positioned at the center of the semicircle, and with the engine noise, shrimp and prawn are driven into the net and are "gilled" through the meshes. The net is usually dyed with extracts of bakawan bark (Domantay, 1973).

At present, a trinal gill net which has a small mesh net sheet in the center and large mesh net sheets on either sides, consisting of 3 net sheets used to trammel prawns, are not common yet in the Philippines.

Probably, the prawns cannot detect the fine net at night.

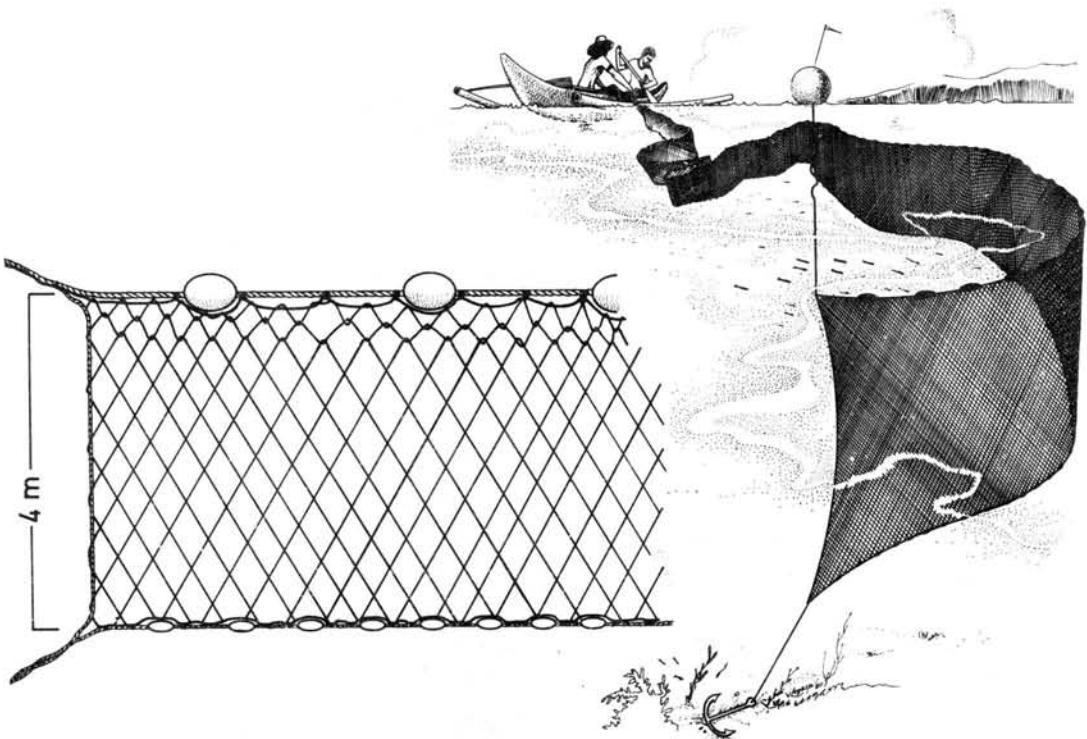

Fig. 34. Operational view of gill net.

DISCUSSION

I. Gears for collecting prawn fry

Among nine kinds of gear, fry lures and fry scare line are devices which exploit the tendency of sugpo fry to cling to solid objects. The same is true of the scoop net which captures the clinging fry. The use of the fry filter net, the Capiz patterned filter net, the triangular net, and fry bulldozer is also based on the migrating behaviour of the sugpo fry to shore waters and penetrating further into brackishwaters, such as mangrove areas, with the incoming tide. Some of these gears are also used for collecting bangos fry (milkfish, *C. chanos*).

During the present survey, it was observed that the fry collectors, after selecting sugpo fry, discarded onto the dry sand the remaining planktonic organisms, which contained plenty of potentially useful prawn fry as well as fry of finfish and crabs.

The present author therefore strongly recommends the following:

1) Since sugpo fry are generally few in number, while other cultivable fry such as *P. indicus*, *P. merguensis* and *P. japonicus* are almost always predominant in shore waters, the collection of these more abundant fry is highly recommended. It is envisioned to result in more income for rural people.

2) After sorting out the prawn fry, the remaining organisms such as finfishes and crabs should be returned to the sea which is only a meter or two away from the sorting place to help conserve natural resources.

II Gear for collecting adult prawns and shrimps

According to biologists and fishermen prawns are mainly nocturnal, thus the fishing gear such as skimming nets and trawlers are operated at night, particularly during the new moon phase. Fish corrals are operated day and night and the harvest is made in the early morning. Furthermore, many existing lift nets and lever nets use kerosene torch lights at night to attract prawns instead of utilizing water movement or current. On the other hand, filter nets and fish corrals are adapted to the migratory behaviour of prawns which tend to move towards the open sea with the outgoing tidal current particularly at night or after heavy rains. For these reasons almost all types of gear are located in places where there are strong currents and face inshore or upstream to enable the capture of prawn migrating to the open sea.

During the present survey, it was often observed that several types of gear such as skimming nets and baby trawlers were operated in mangrove areas, the interior portion of a bay and big rivers which are important nursery grounds of prawns, shrimps and other useful marine species. The catch consists mainly of juvenile and/or adolescent prawns and shrimps which command a low market price due to their smaller sizes. Capture of these small shrimps should be banned to conserve aquatic resources.

As a general observation, it is very interesting to note that the types of gears mentioned above are well adapted to the behavioral patterns of shrimps and prawns

and were developed and modified by rural fishermen through their experience. The gears sometimes give scientists, who are engaged in prawn ecology and biology, valuable information on prawn behaviour.

Needless to say, most of the gears described here are also used for catching other commercially important animals such as crabs and finfishes.

REFERENCES

- 1) Anonymous, 1978. Fishery statistical bulletin for South China Sea area. Training Department of Southeast Asian Fisheries Development Center (SEAFDEC), Thailand. 172 pp.
- 2) Brandt, A., 1972. Fish catching methods of the world. Fishing News (Books) Ltd., London, 240 pp.
- 3) Delmendo, M.N. and H.R. Rabanal, 1973. Cultivation of "sugpo" (Jumbo tiger shrimp), *Penaeus monodon* Fabricius in the Philippines. Phil. J. Fish., 8(2):159-175.
- 4) Domantay, J.S., 1973. Prawn fisheries of the Philippines. Phil. J. Fish., 8(2):197-211.
- 5) Motoh, H., 1980. Traditional devices and gears for collecting fry of "sugpo" giant tiger prawn, *Penaeus monodon* in the Philippines. Technical Report No. 4, Aquaculture Department of SEAFDEC, 17 pp.
- 6) Primavera, J.H. and F.P. Apud, 1977. Manual of operation: Sugpo pond culture. Extension Manual of the Aquaculture Department, SEAFDEC, No. 2, 18 pp.
- 7) Rounsefell, G.A., 1975. Fishing gears and their characteristics. In Ecology, Utilization and management of marine fishing, 163-702.
- 8) Talavera, F. and H.R. Montalban, 1932. Fishing appliances of Panay, Negros, and Cebu. Phil. J. Sci., 48(3): pp. 429-479, pls. 1 to 15.
- 9) Umali, A.F., 1950: Guide to the classification of fishing gear in the Philippines. U.S. Fish Wildl. Serv., Res. Rep. 17:i-iv, 1-165, Figs. 1-53.

ACKNOWLEDGEMENT

The author wishes to express his sincere gratitude to Dr. Katsuzo Kuronuma, Ex-President of the Tokyo University of Fisheries, and Dr. Hiroshi Kurata of the Nansei Regional Fisheries Research Laboratory, for their valuable advice through the study and review of this manuscript.

The author is also grateful to Dean Rogelio O. Juliano, Department chief, and Mr. Kunio Katsutani, Deputy chief of the Aquaculture Department of the Southeast Asian Fisheries Development Center (SEAFDEC), for approving and supporting the continuation of the present study for two years in the Philippines.

The author also extends his warmest thanks to Dr. Joseph C. Madamba, Director of SIA and Dr. Thomas G. Flores, Deputy Director who made possible the publication of this manuscript.

Thanks are also due to Mr. Noel Solis, Miss Edna Caligdong, Miss Fely Boblo and Miss Mila Gelangre of the Aquaculture Department, SEAFDEC, for their kind assistance in the collection of the information.

The author is further greatly indebted to Dr. James Norfolk, Mrs. Jurgenne Primavera, Ms. Leny Rodriguez and Miss Alexandrina Benedicto of the SEAFDEC Aquaculture Department for reading the manuscript.

Finally, special thanks go to Mr. Panfilo Legaspi, Jr., for preparing the illustrations without which this work would be far from useful.

